

# TM 5-6115-376-13

DEPARTMENT OF THE ARMY TECHNICAL MANUAL

---

OPERATOR, ORGANIZATIONAL AND DIRECT  
SUPPORT MAINTENANCE MANUAL,  
GENERATOR SET, DIESEL ENGINE, TRAILER MOUNTED  
PU-407/M (FSN 6115-702-3347)  
AND PU-699/M (FSN 6115-132-0488), AND  
GENERATOR SET, DIESEL ENGINE, TRUCK MOUNTED  
PU-408/M (FSN 6115-706-0469)  
AND PU-700/M (FSN 6115-125-7876)

---

This copy is a reprint which includes current  
pages from Changes 1 through 3.

HEADQUARTERS, DEPARTMENT OF THE ARMY  
AUGUST 1970

## **WARNING PAGE**

Do not operate generator set in an enclosed area unless exhaust gases are piped outside. Inhalation of exhaust fumes may result in serious illness or death.

Do not perform any maintenance on generator set, controls, instruments, or wiring when unit is operating or connected to external power lines. Disconnect batteries while performing maintenance on engine controls or instruments.

Do not smoke or use an open flame in vicinity when servicing batteries. Batteries generate hydrogen, a highly explosive gas. Failure to observe this warning may result in injury or death to personnel.

Do not fill fuel tank while engine is running. Fuel spilled on hot engine may explode and cause serious injury or death to personnel.

When filling fuel tank, do not smoke or use an open flame in immediate vicinity. Always provide metal-to-metal contact between container and fuel tank to prevent sparks as fuel flows over metallic surfaces. Failure to observe this warning may result in death to personnel.

Do not operate generator sets without suitable ground connections. Electrical defects in unit load lines or load equipment can cause death by electrocution when contact is made with an ungrounded system.

CHANGE }  
No. 3 }

HEADQUARTERS  
DEPARTMENT OF THE ARMY  
WASHINGTON, D.C. 3 January 1975

Operator's, Organizational and Direct  
Support Maintenance Manual  
GENERATOR SET, DIESEL ENGINE, TRAILER  
MOUNTED PU-407/M (FSN 6115-702-3347)  
AND PU-699/M (FSN 6115-132-0488), AND GENERATOR  
SET, DIESEL ENGINE, TRUCK MOUNTED, PU-408/M  
(FSN 6115-706-0469) AND PU-700/M,  
(FSN 6115-125-7876)

TM 5-6115-376-13, 4 August 1970, is changed as follows:

Page 1-1, paragraph 1-2 is superseded as follows:

1-2. Recommendation for Maintenance Publications Improvements

You can improve this manual by recommending improvements. Your letter or DA Form 2028 (Recommended Changes to Publications and Blank Forms) or by letter, and mail direct to Commander, US Army Troop Support Command, ATTN: AMSTS-MPP, 4300 Goodfellow Boulevard, St. Louis, MO. 63120. A reply will be furnished direct to you.

Page 2-2. Paragraph 2-4, add paragraph c as follows:

c. Grounding Procedure.

**CAUTION**

Generator sets should be grounded in order to prevent shock due to defective insulation or external electrical faults. Poor grounding can endanger personnel, may damage equipment, and can create interference in communication or electronic circuits.

(1) Install one of the following items as a grounding device:

(a) Drive a ground rod to depth of at least 8 feet. This is the preferred device which is available in the Army Supply System.

(b) Drive a ground pipe, 3/4 inch, copper or steel, to a depth of at least 8 feet. An existing underground pipe may be used in an emergency.

(c) Bury a 1/4 inch thick iron or steel plate, approximately 18 inch x 18 inch size with ground cable attached, a depth of at least 4 feet.

(d) Bury a 1/16 inch thick aluminum or copper plate approximately 18 inch x 18 inch size, with ground cable attached, to a depth of at least 4 feet.

(2) Saturate the area around the grounding device with water to increase conductivity.

(3) Connect the ground cable from the grounding device to the operator set frame ground rods (fig 1-2) and tighten the nut securely.

**NOTE**

Ground cables should be copper. Braided cable is the best, but No. 6 AWG gage (or larger) copper wire will suffice.

By Order of the Secretary of the Army:

FRED C WEYAND  
*General, United States Army*  
*Chief of Staff*

Official

VERNE L. BOWERS  
*Major General, United States Army*  
*The Adjutant General*

**Distribution:**

**To be distributed in accordance with DA Form 12-25D (qty rqr block No. 781), Operator requirements for Truck and Trailer Mounted Generators (PU's).**

Change }  
No. 2 }

HEADQUARTERS  
DEPARTMENT OF THE ARMY  
Washington, DC 24 June 1974

**Operator, Organizational, and Direct Support  
Maintenance Manual  
GENERATOR SET, DIESEL ENGINE; TRAILER-MOUNTED;  
PU-407/M, FSN 6115-702-3347; PU-699/M, FSN 6115-132-0488;  
AND TRUCK-MOUNTED, PU-408/M, FSN 6115-706-0469;  
PU-700/M, FSN 6115-125-7876**

TM 5-6115-376-13, 4 August 1970, is changed as follows:

Warning Page, and Page 2-14, paragraph 2-14, add the following:

**WARNING**

Operation of this equipment presents a NOISE HAZARD to personnel in the area.

The noise level exceeds the allowable limits for unprotected personnel. Wear ear muffs or ear plugs which were fitted by a trained professional.

**WARNING**

Cleaning solvent, PD-680, is POTENTIALLY DANGEROUS CHEMICAL. Do not use near open flame.

By Order of the Secretary of the Army:

Official:

VERNE L. BOWERS  
Major General, United States Army  
The Adjutant General

CREIGHTON W. ABRAMS  
General, United States Army  
Chief of Staff

Distribution:

To be distributed in accordance with DA Form 12-25D (qty rqr block No. 781), Operator requirements for Truck & Trailer Mounted Generators (PU's).



Change }  
No. 1 }

HEADQUARTERS  
DEPARTMENT OF THE ARMY  
Washington, D.C. 11 July 1972

**Operator, Organizational, and Direct Support  
Maintenance Manual  
GENERATOR SET, DIESEL ENGINE; TRAILER MOUNTED, PU-407/M,  
FSN 6115-702-3347; PU-699/M, FSN 6115-132-0488; AND  
TRUCK MOUNTED, PU-408/M, FSN 6115-706-0469; PU-700/M,  
FSN 6115-125-7876**

TM 5-6115-326-13, 4 August 1970, is changed as follows:

*Page C-1.* Appendix C is rescinded. There are no basic issue items or items troop installed for these generator sets.

By Order of the Secretary of the Army:

BRUCE PALMER, JR.  
*General, U. S. Army  
Acting Chief of Staff*

Official:

VERNE L. BOWERS,  
*Major General, United States Army,  
The Adjutant General.*

Distribution:

To be distributed in accordance with DA Form 12-25D, (qty rqr block No. 781) operator maintenance requirements for Truck and Trailer Mounted Generators (PU's).





**OPERATOR, ORGANIZATIONAL AND DIRECT SUPPORT  
 MAINTENANCE MANUAL**

**GENERATOR SET, DIESEL ENGINE,  
 TRAILER MOUNTED, PU-407/M, FSN 6115-702-3347, AND PU-699/M,  
 FSN 6115-132-0488, AND GENERATOR SET, DIESEL ENGINE, TRUCK  
 MOUNTED, PU-408/M, FSN 6115-706-0469, AND PU-700/M, FSN  
 6115-125-7876**

	Paragraph	Page
CHAPTER 1. INTRODUCTION		
Section I. General _____	1-1,1-2	1-1
II. Description and data -----	1-3-1-17	1-1-1-16
CHAPTER 2. OPERATING INSTRUCTIONS		
Section I. Service upon receipt of materiel_ _ _ _ _	2-1-2-7	2-1-2-4
II. Movement to new worksite _____	2-8,2-9	2-6
III. Controls and instruments -----	2-10,2-11	2-6
IV. Operation under usual conditions _____	2-12-2-16	2-14-2-15
v. Operation under unusual conditions _____	3-17,2-18	2-16
VI. Operation of materiel used in conjunction with the equipment _____	2-19,2-20	2-16
CHAPTER 3. OPERATOR'S MAINTENANCE INSTRUCTIONS		
Section I. Basic issue items _____	3-1,3-2	3-1
II. Lubrication instructions -----	3-3,3-4	3-1
III. Preventive maintenance checks and services -----	3-5,3-6	3-1
IV. Troubleshooting _____	3-7	3-3
V. Maintenance of generator sets -----	3-8,3-9	3-3
CHAPTER 4. ORGANIZATIONAL MAINTENANCE INSTRUCTIONS		
Section I. Service upon receipt of materiel _____	4-1	4-1
II. Repair part, special tools and equipment -----	4-2-4-4	4-1
III. Preventive maintenance checks and services -----	4-5,4-6	4-1
IV. Troubleshooting -----	4-7,4-8	4-4
V. Maintenance of generator sets -----	4-9-4-20	4-5 4 1 2
CHAPTER 5. DIRECT SUPPORT MAINTENANCE INSTRUCTIONS		
Section I. Repair parts, special tools and equipment _____	5-1-5-3	5-1
II. Troubleshooting _____	5-4	5-1
III. General maintenance _____	5-5	5-2
IV. Removal and installation of major components and auxiliaries _____	5-6-5-10	5-2,5-3
CHAPTER 6. REPAIR INSTRUCTIONS		
Section I. Repair of generator sets, cargo trucks and trailers -----	6-1,6-2	6-1
II. Repair of distribution box, portable distribution boxes, synchroniser assembly, switches, and wiring -----	6-3-6-7	6-1-6-11
APPENDIX A. REFERENCES _____		A-1
B. MAINTENANCE ALLOCATION CHART _____		B-1
c. BASIC ISSUE ITEMS LIST _____		C-1
INDEX -----		I-1

\*' This manual supersedes TM 5-6115-376-15, 23 May 1966, including all changes.

**LIST OF ILLUSTRATIONS**

<i>Fig. No.</i>	<i>Title</i>	<i>Page</i>
1-1	Diesel engine generator sets, trailer-mounted PU-407/M (or PU-699/M), and truck-mounted PU-408/M (or PU-700/M) (inset); typical set up of central power source for area-type communications system (background) a_____	1-2
1-2	PU-407/M trailer with Consolidated DE Model 4070 (sheet 1 of 2) _____	1-3
1-2	PU-407/M trailer with Consolidated DE Model 4070 (sheet 2 of 2) -----	1-4
1-3	PU-699/M trailer with military design generator, distribution box and switchbox (sheet 1 of 2). _____	1-5
1 3	PU-699/M trailer with military design generator, distribution box, and switchbox (sheet 2 of 2)_____	1-6
1-4	Accessory box contents (PU-699/M trailer shown) _____	1-7
1-5	PU-408/M truck with Consolidated Model 4070DE _____	1-8
1-6	PU-408/M truck mounted Stewart-Stevenson Model 54400 DE; component location (sheet 1 of 2). -----	1-9
1-6	PU-408/M truck mounted Stewart-Stevenson DE Model 54400DE component location (sheet 2 of 2). _____	1-10
1-7	PU-407/M trailer with Stewart-Stevenson DE generator Model 54400 and synchronizer assembly (sheet 1 of 2). _____	1-11
1-7	PU-407/M trailer with Stewart-Stevenson DE generator Model 54400 and synchronizer assembly (sheet 2 of 2). _____	1-12
1-8	PU-700/M truck mounted Onan military design generator with distribution box and switchbox (sheet 1 of 2) _____	1-13
1-8	PU-700/M truck mounted Onan military design generator with distribution box and switchbox (sheet 2 of 2) _____	1-14
1-9	Distribution box, front (cover open). (PU-407/M, PU-408/M)_____	1-15
1-10	Distribution box, front (side panels in place). (PU-407/M, PU-408/M)_____	1-16
1-11	Synchronizer assembly (PU-407/M only) _____	1-17
1-12	Portable distribution boxes (all units). _____	1-18
1-13	Sling assembly (PU-408/M, PU-700/M). _____	1-19
1-14	Towing cable assembly (PU-408/M, PU-700/M) _____	1-19
1-15	Power cable, reel, and holddown rod, (all units). _____	1-20
2-1	Generator trailer, front landing leg assembly (PU-407/M, PU-699/M)_____	2-2
2-2	PU-407/M accessory box contents _____	2-3
2-3	Inter unit cabling diagram with synchronizer assembly (PU-407/M, PU-408/M). _____	2-4
2-4	Inter unit cabling diagram. PU-699/M, PU-700/M. _____	2-5
2-5	DE generator set, showing typical controls and instruments -----	2-7
2-6	Trailer mounted DE generator set PU-407/M, ready for operation. _____	2-8
2-7	Distribution box controls (PU-699/M, PU-700/M). _____	2-9
2-3	Synchronizer assembly controls indicators and instruments. -----	2-10
2-9	Wiring diagram of synchronizer assembly. -----	2-11
2-10	Electronic synchronizer, location of parts. -----	2-12
2-11	Switch box controls (PU-699/M). -----	2-13
4-1	Removal and installation of generator set batteries. _____	4-6
4-2	Removal and installation of 45KW power cables (PU-407/M; PU-408/M similar)_____	4-7
4-3	Testing switch box of PU-699/M. --- -----	4-9
4-4	Removal and installation of connector-receptacle of distribution boxes. _____	4-10
4-5	Removal and installation of connector-receptacle of portable distribution boxes. -----	4-11
4-6	Distribution box indicator lights, removal and installation. _____	4-13
4-7	Synchronizer assembly indicator lights lens and wiring, removal and installation (sheet 1 of 2). -----	4 14
4-7	Synchronizer assembly indicator lights, lens and wiring, removal and installation (sheet 2 of 2). _____	4-15
4-3	Synchronizer assembly power receptacle cover and dust cap clamp removal and installation. _____	4-16
4-8	Synchronizer assembly power receptacle-connector, parallel receptacle-connector, bus bar and power leads, removal and installation (sheet 1 of 2). -----	4-17

<i>Fig. No.</i>	<i>Title</i>	<i>Page</i>
4-9	Synchronizer assembly power receptacle-connector, parallel receptacle-connector, bus barandpower leads, removal and installation. (sheet 2 of 2). _____	4-18
4-10	Synchronizer assembly toggle switches removal and installation. -----	4-19
4-11	Connector-receptacle and cover (switchbox removal and installation) (Sheet 1 of 2). _____	4-20
4-11	Connector-receptacle and cover (switchbox removal and installation) (sheet 2 of 2).-----	4-21
6-1	Lowering of DE generator unit into skid platform. _____	5-4
6-2	Skid platform holddown assembly. -----	5-5
6-3	Lifting sling assembly in use. -----	5-6
6-4	Skid platform, ready formounting of DE generator unit, -----	5-7
6-1	Distribution box circuit breakers andammeters, removal and installation. -----	6-2
6-2	Lamp socket assemblies and chain removal and installation (distribution box, all units). _____	6-3
6-3	Distribution panel, removal and installation (all units). _____	6-4
6-4	Current transformers, removal and installation (distribution box, all units) -----	6-6
6-5	Portable distribution box panel components, removal and installation -----	6-6
6-6	Automatic switch assembly, removal and installation. _____	6-7
6-7	Automatic switch disassembly and reassembly. -----	6-8
6-8	Automatic switch adjustment. -----	6-9
6-9	Relay switch assembly and electronic synchronizer switch assembly, removal and installation. _____	6-10
6-10	Switchhox circuit breaker switches, removal and installation (sheet 1 of 2)._____	6-12
6-10	Switchbox circuit breaker switches, removal and instillation (sheet 2 of 2). _____	6-13



## CHAPTER 1

## INTRODUCTION

**Section I. GENERAL****1-1. Scope**

*a.* This manual contains instructions for use of operator, organizational and direct support maintenance personnel maintaining the 45 KW PU-407/M and PU-408/M, and the 60 KW PU-699/M and PU-700/M generator sets. Also included are descriptions of main units and their functions in relation to other components.

*b.* Refer to TM 740-90-1 (Administrative Storage of Equipment) for information and instructions pertaining to organizational administrative storage.

*c.* Refer to TM 750-244-3 (Procedures for Destruction of Equipment to Prevent Enemy Use) for information and instructions for destruction of equipment to prevent enemy use.

**1-2. Forms and Records**

*a.* Maintenance forms, records, and reports which are to be used by maintenance personnel at all maintenance levels are listed in and prescribed by TM 38-750.

*b.* Report of errors, omissions, and recommendations for improving this publication by the individual user is encouraged. Reports should be submitted on DA Form 2028 (Recommended Changes to Publications), and forwarded direct to Commanding General, U.S. Army Mobility Equipment Command, ATTN : AMSME-MPP, Goodfellow Blvd., St. Louis, Mo. 63120.

**Section 11. DESCRIPTION AND DATA****1-3. Description**

*a.* The trailer mounted PU-407/M and truck mounted PU-408/M generator sets are 45 KW military design (MIL-G-14609) manufactured by Consolidated (Model 4070) or Stewart-Stevenson (Model 64400) ; 120 volt, 60 hertz, three-phase, diesel engine driven generators. These units may be arranged for joint operation as primary, standby, or individual power source, and each unit provides up to nine power connecting facilities.

*b.* The PU-407/M and PU-408/M are used jointly to provide a 45KW central power source for components composing an area-type communication system as shown in figure 1-1.

*c.* The trailer-mounted PU-699/M and truck-mounted PU-700/M generator sets are equipped with 60 KW, 60 hertz military design model SF-60MD/CIED. These two units also may be operated as primary, standby, or individual power sources, and provide a 60KW central power source for components of an area-type communications system. The military design sets use a Cummins Model C-180 diesel engine coupled with an Onan

Division of Studebaker Corp. 50/60 Hertz rotating field generator model SF.

*d.* The 60KW units (PU-699/M and PU-700/M) have load transfer and paralleling capability built in (fig. 1-3).

**1-4. Differences Between Models**

This manual covers the PU-407/M and PU-408/M 45KW diesel engine generator sets, and the PU-699/M and PU-700/M 60 KW units. The PU-407/M and PU-699/M are trailer mounted on the M200A1 trailer. The PU-408/M and PU-700/M units are truck mounted on the M54A2 truck. Where differences exist (mostly in minor component location and refinements in switching) each model is covered separately in applicable sections of this manual. The PU-407/M is to be used with the PU-408/M, and the PU-699/M is to be used with the PU-600/M because of the KW differences.

**1-5. Tabulated Data**

*a.* Diesel Engine Generator Set, Consolidated Model 4070 (u/o PU-407/M, PU-408/M), (TM 5-6115-239-10).



Figure 1-1. Diesel engine generator sets, trailer-mounted PU-407/M (or PU-699/M), and truck-mounted PU-408/M (or PU-700/M) (inset); typical set up of central power source for area-type communications system (background).

**Engine:**

Type ----- Diesel, Diesel, four-stroke cycle  
 Fuel consumption ----- 3.38 gallons/hour  
 Fuel tank capacity ----- 43 gallons  
 Electrical system ----- 24 volts, DC, negative ground  
 Cooling system ----- Liquid, 32 quart capacity  
 Crankcase capacity ----- 13 quarts

**Generator:**

Type ----- Synchronous  
 Frequency ----- 60 hertz  
 Power factor ----- 0.8  
 Phase ----- 3  
 Wires ----- 4  
 Volts ----- 120  
 Amperes ----- 270  
 Power ----- 45KW

**Heater:**

Type ----- Gasoline  
 Operating voltage ----- 24-28 VDC  
 Heat output ----- 25,000 BTUH

Fuel consumption ----- 0.43 gph  
 Fuel tank capacity ----- 1 gallon

**h. Diesel Dimensions.**

Length ----- 89 inches  
 Width ----- 36 inches  
 Height ----- 59 inches  
 Weight ----- 3,961 lbs.

**c. Diesel Engine Generator Set, Stewart-Stevenson Model 54400 (u/o PU-407/M, PU-408/M) (TM 5-6115-247-15).**

**Engine:**

Type ----- Diesel, two cycle  
 Fuel consumption ----- 3.75 gallons per hour  
 Fuel tank capacity ----- 30 gallons  
 Electrical system ----- 24 volts DC  
 Cooling system ----- 5.75 gallons  
 Crankcase capacity ----- 15 quarts

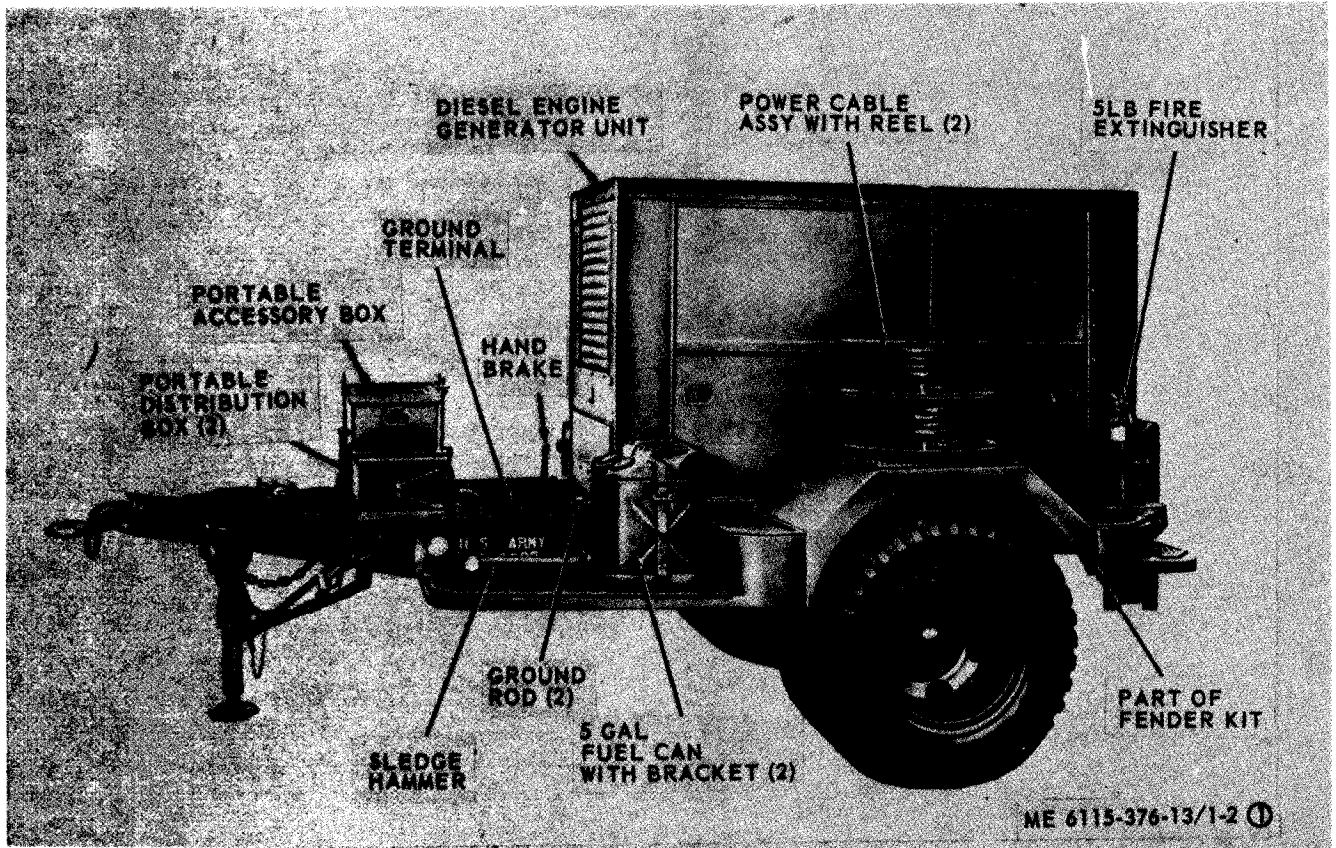

Figure 1-2. PU-407/M trailer with consolidated DE Model 4070 (sheet 1 of 2).

**Generator:**

Type ----- Synchronous  
 Frequency ----- 50/60 hertz  
 Power factor ----- 0.8  
 Phase ----- 3  
 Wires ----- 4  
 Volts ----- 120/208 or 240/416  
 Amperes ----- 156 or 78  
 Power ----- 45 KW  
 RPM ----- 1,800

**Heater:**

Type ----- Gasoline  
 Heat output ----- 20,000 BTUH  
 Fuel Consumption ----- 0.6 gallons/hr.

**d. Diesel Dimensions.**

Length ----- 81 inches  
 Width ----- 36 inches  
 Height ----- 54-1/2 inches  
 Weight ----- 3,620 lbs.

**e. Trailer (M200A1, 2-1/2 Ton, 2 Wheel, Generator (U/O PU-407/M, PU-699/M). (TM 9-2330-205-14).**

Towing facilities --- Lunette  
 Towing vehicle ----- 5 Ton, 6 x 6  
 Brakes ----- Air over hydraulic  
 Handbrakes (2) ----- Mechanical, hand-lever controlled  
 Tires, pneumatic (4) --- Normal use 45 psi; mud, snow and sand, 15 psi.

Voltage (lighting) --- 24 VDC

Weight ----- 2550 lbs (less fender assembly).

**f. Truck, Cargo, 5 Ton, 6 x 6, M54A2 (U/O PU-408/M, PU-700/M). (TM 9-2320-211-10).**

Engine ----- 4 cycle, 6 cylinder, valve-in head  
 Cooling system ----- Liquid, 44 qts.  
 Fuel consumption ----- 4.44 mpg  
 Fuel tank capacity ----- 78 gallons  
 Crankcase capacity ----- 22 qts.

Electrical system ----- 24 VDC (negative ground)

**Cruising range**

(loaded at 30 mph) ----- 24 Miles (344 kilometers)

Fording depth ----- 30 inches (76 centimeters)

**Recommended towed**

**load:**

Highway ----- 30,000 lbs. (Max).

Cross-country ----- 15,000 lbs. (Max).

Height ----- 116 inches

Length ----- 314 inches

Width ----- 97 inches

Tires ----- 11.00 x 20

**Tire inflation:**

Highway ----- 70 psi.

Cross-country ----- 35 psi.

Mud, snow or sand ----- 15 psi.

**g. Distribution Box (U/O PU-407/M, PU-408/M).**

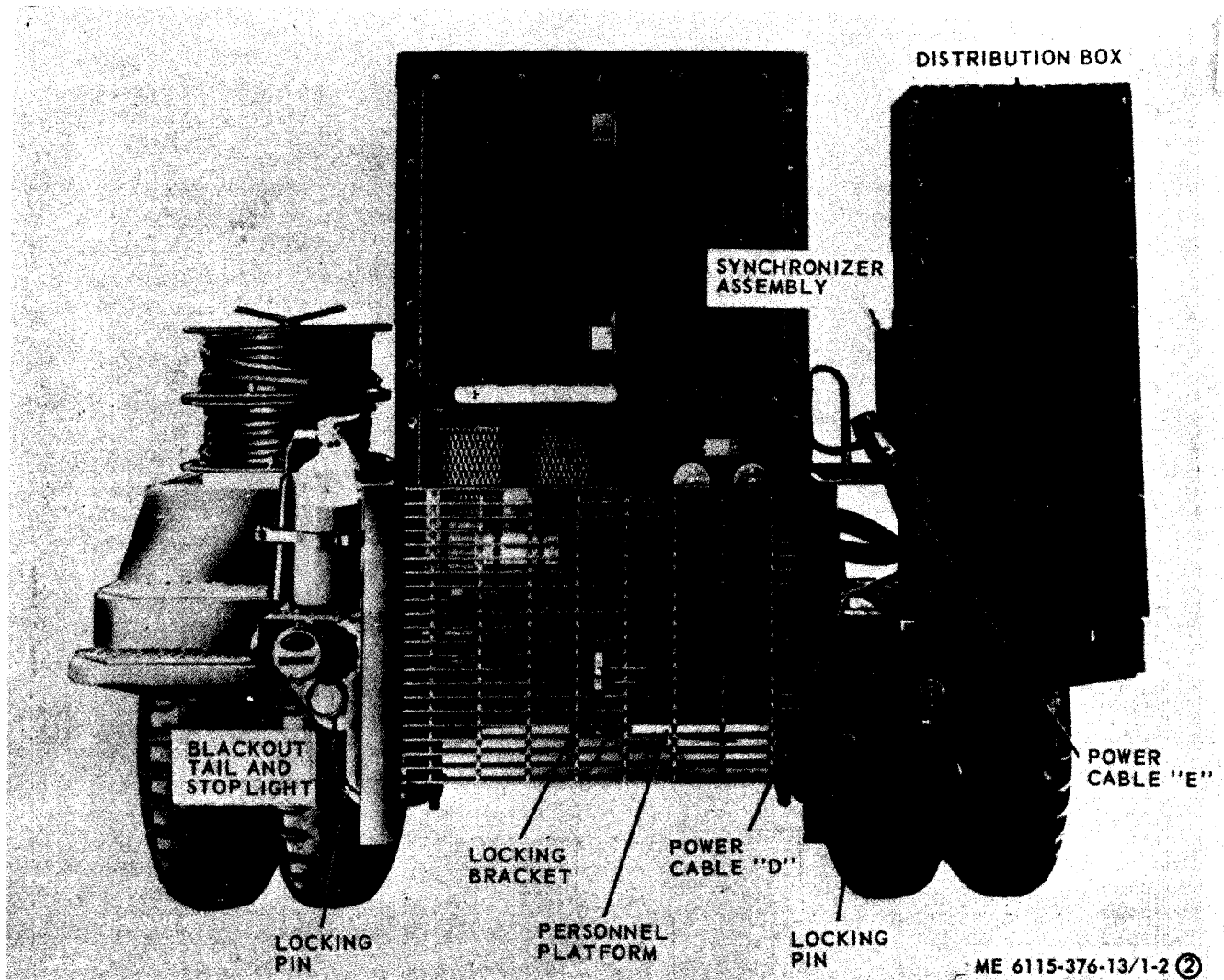

Figure 1-2. PU-407/M trailer with consolidated DE Model 4070 (sheet 2 of 2).

(1) Control panel: (fig. 1-2(2)).

- Input circuit (from generator) ----- 3 phase, 120 volt, 60 hertz, 4 wire
- Output circuits (to distribution panel) ----- 9 120 volt, 60 hertz 2 wire
- Circuit control switches -- 9 circuit breakers, 70 amps (3 per phase)
- Indicators:
  - Meters (3) ----- 0-200 amp scale (one per phase)
  - Lamps (9) ----- 120 VAC, near (one per circuit breaker).

(2) Distribution panel

- Output connectors (9)
  - Type ----- 8 contact connectors
  - Working contacts ----- 3 (including one ground lead)
- h. Distribution Box (U/O PU-699/M, PU-700/M).

MERCD drawing 13216E7470; FSN 6110-485-9212 contains 3 ammeters (0-500 amps), 9 lamps and 9 toggle switches on control panel; and 9 connectors (3 per phase) on distribution panel. Size, purpose and arrangement of components similar to g. above (fig. 1-3(1)).

i. Portable Distribution Boxes (All Units).

There are two portable distribution boxes on each trailer (PU-407/M and PU-699/M), and six on each truck (PU-408M and PU-700/M). Input (from distribution panel of distribution box) is single phase, 120 volt, 60 hertz, 2 wire power. The single input is an 8 contact connector, and the six outputs are AC duplex receptacles. The six switches are circuit breakers 15-amp, one for each output receptacle. The six lamps are 120 volt AC neon, one per circuit breaker. (See fig. 1-3(1)).



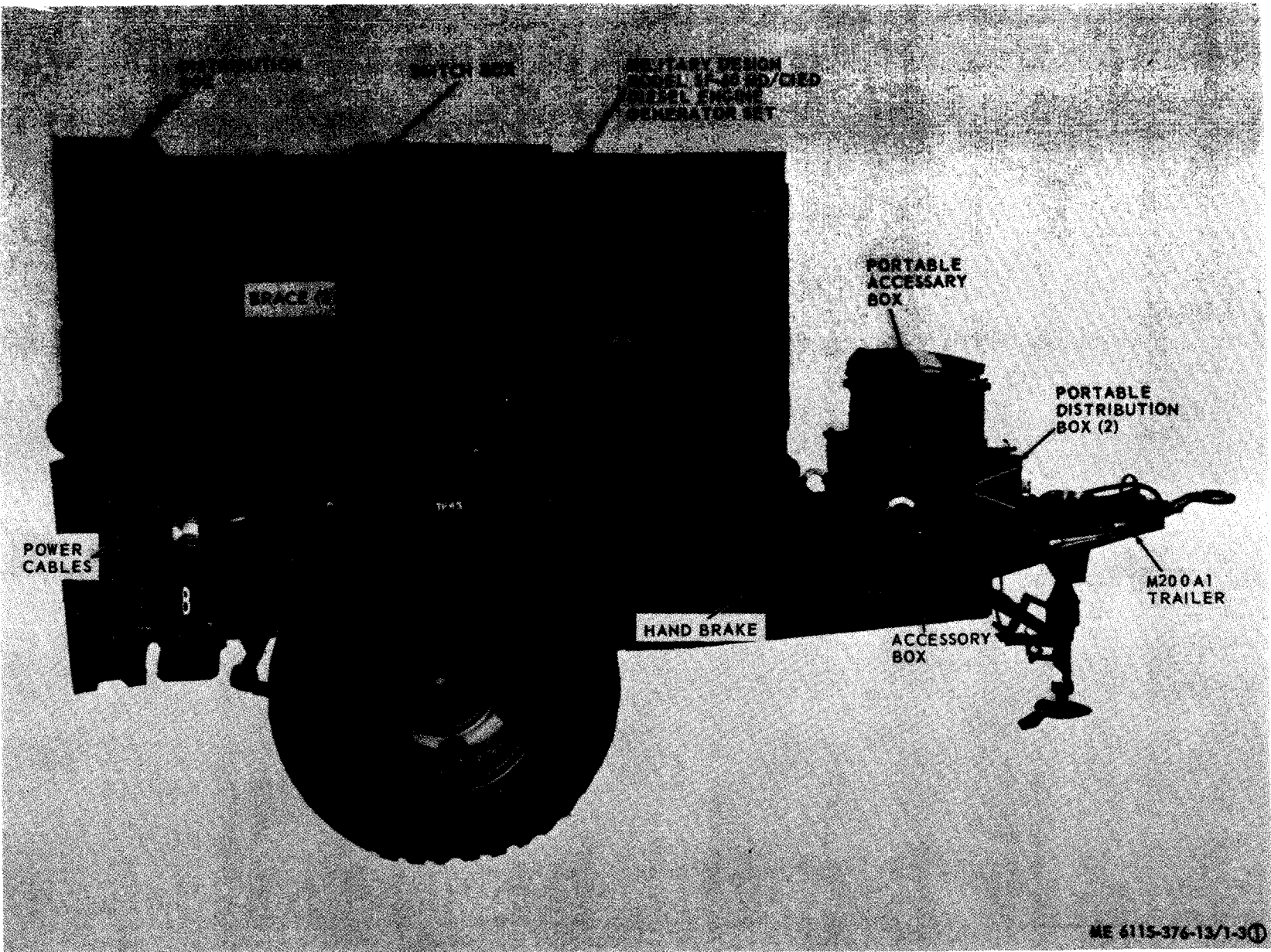
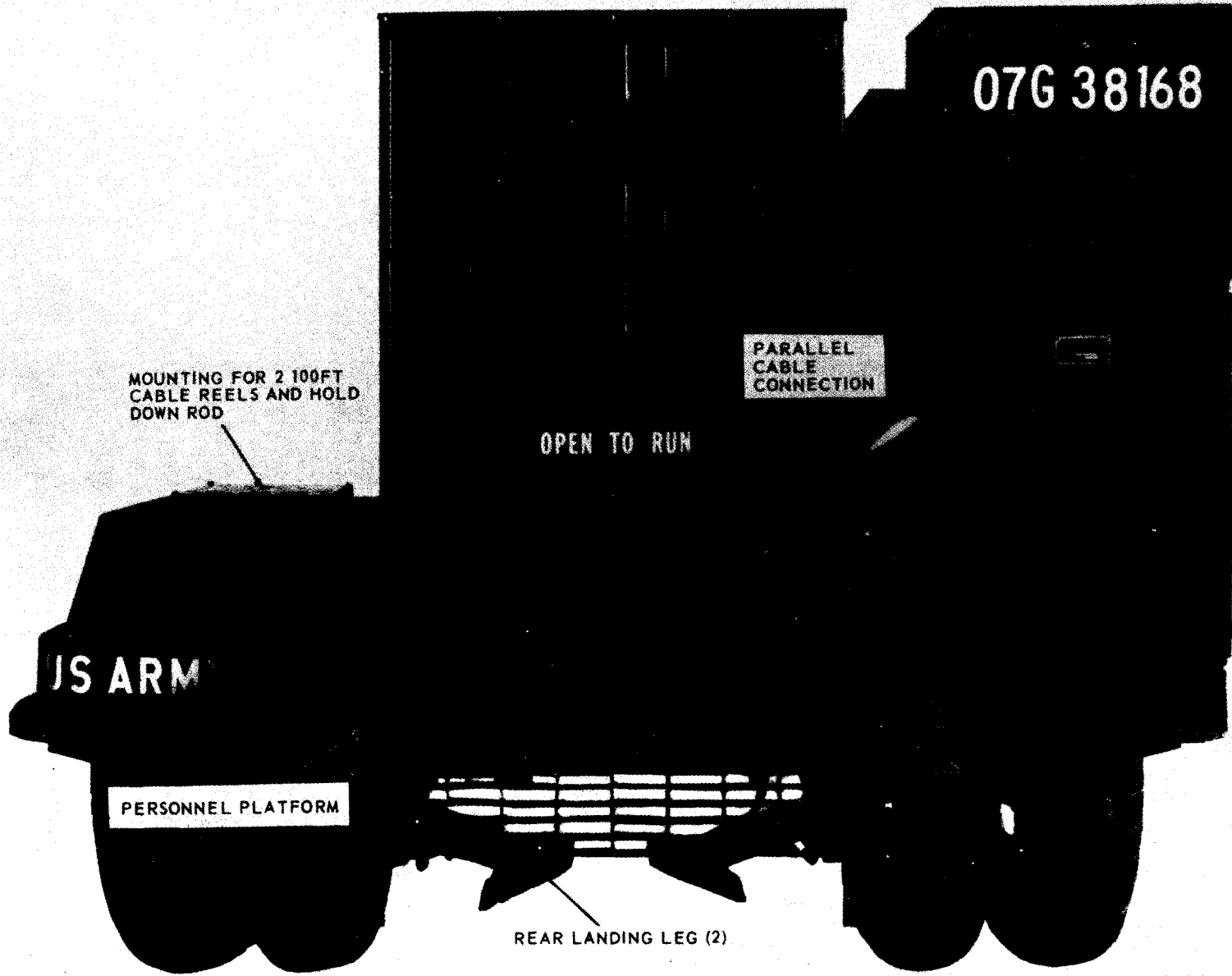

Figure 1-3. PU-699/M trailer with military design generator, distribution box, and switchbox (sheet 1 of 2).



ME 6115-376-13/1-3 ②

Figure 1-3. PU-699/M trailer with military design generator, distribution box, and switchbox, (sheet 2 of 2).

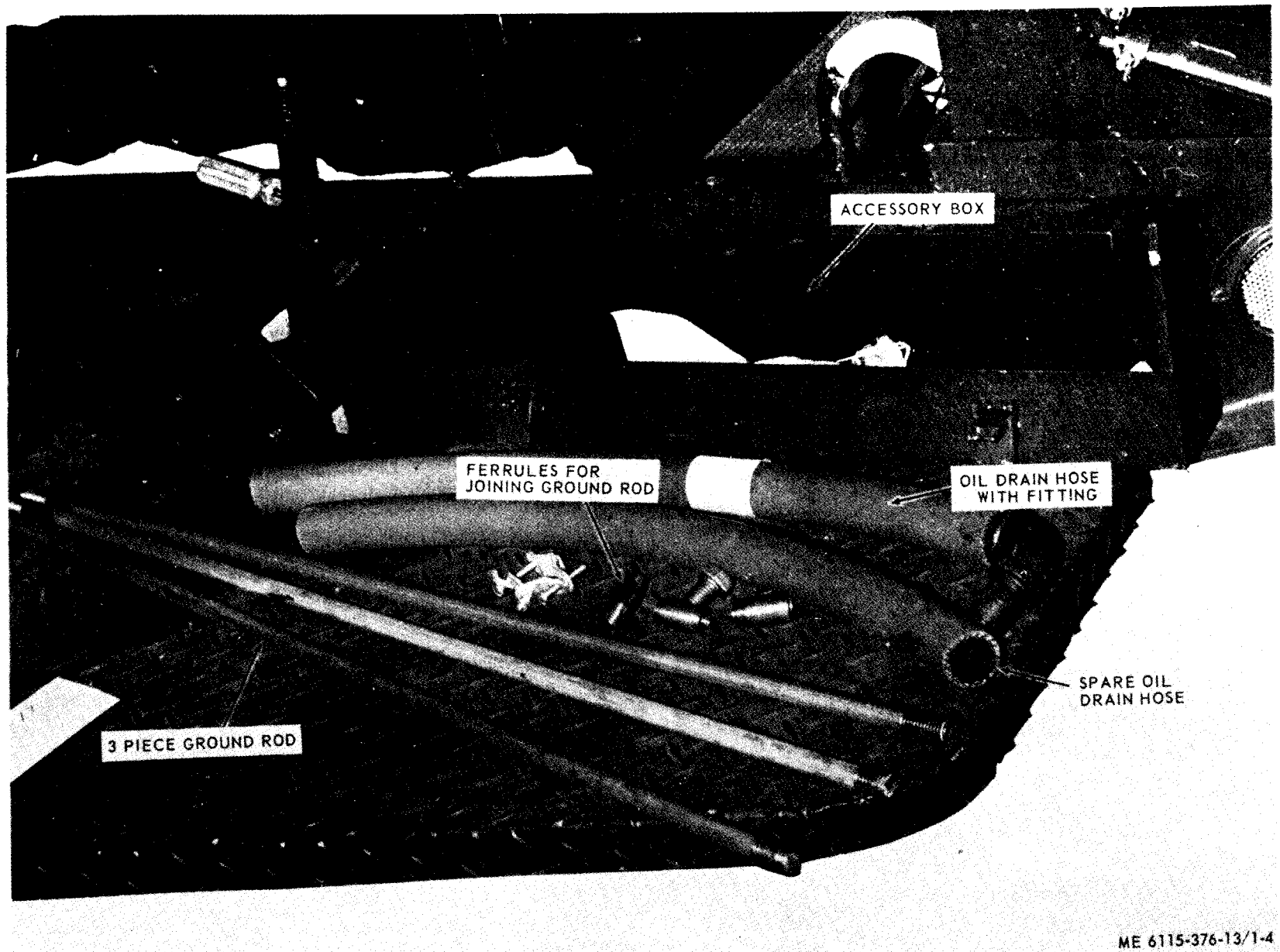

Figure 1-4. Accessory box contents (PU-699/M trailer shown).

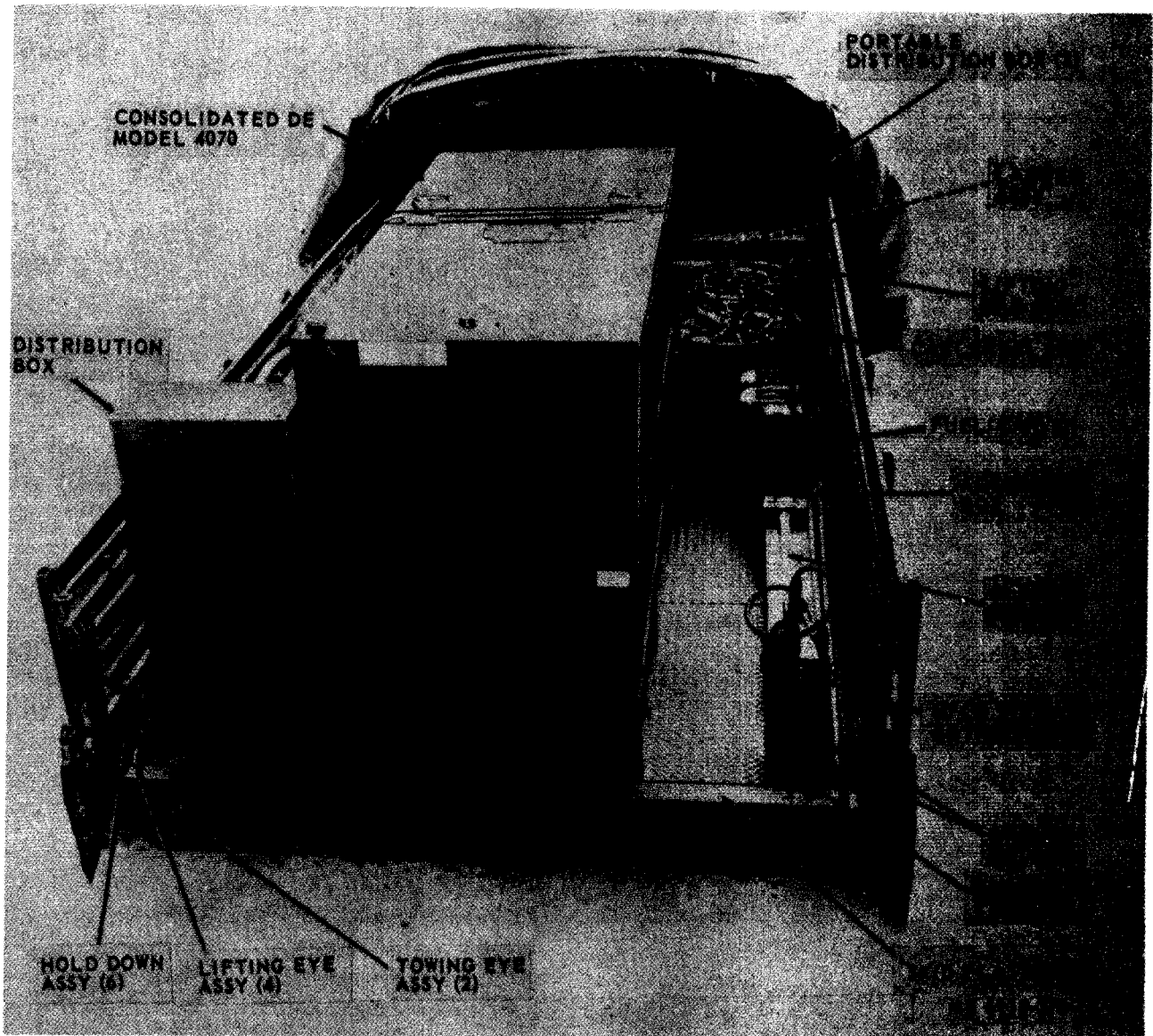

Figure 1-5. PU-408/M truck with consolidated Model 4070DE.

*j. Synchronizer Assembly (P U-4 07/M) (fig. 1-11).*

- Capacity ----- 90 KW
- Switch ----- Magnetically activated by a voltage frequency, and phase sensing circuit.
- Voltage ----- 3 phase, 120 volt, 60 hertz, 4 wire.
- Connecting facilities Two input, two output, all 4-contact male connectors
- Interconnecting facilities ----- Two power and two sensing voltage; all 4-contact male connectors.

*k. Switch box (PU-699/M) (fig. 1-3(1)).*

- MERDC drawing 13216 E7558 ----- FSN 6110-485-9211
- Circuit breaker ----- 4 toggle switches

Connections:

- Input (2) (from generators) ----- 4 pin (including 1 ground) connector ZZM-WFB-17724-21P. (labelled GEN 1, GEN 2)
- Output (2) (from distribution boxes) ----- 4 Socket (including 1 ground) type ZZM-WFB-17724-21S, labelled load 1, load 2.

*l. Accessory box (PU-407/M, PU-699/M).*

Located front curbside of trailer near handbrake. Contains two 3-piece ground rods with clamps, oil drain hose with threaded fitting, a spare oil drain hose, fuel can spout and fuel drum adapter (MERDC drawing 13214E1429), as shown in figure 1-4. (fig. 2-2 for PU-407/M).

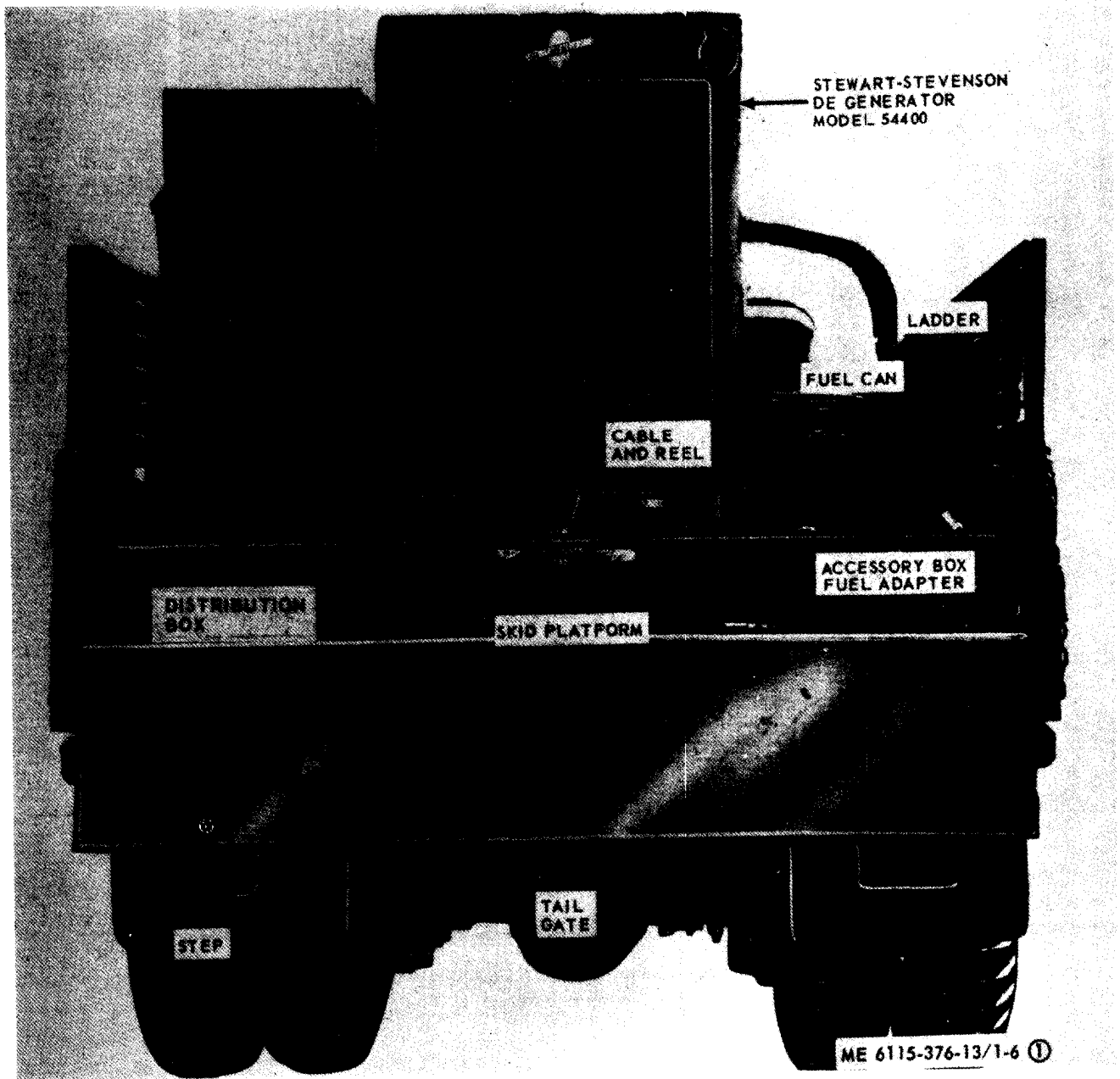

Figure 1-6, PU-h08/M truck mounted Stewart-Stevenson Model 54400DE; component location (Sheet 1 of 2).

m. *Accessory Box (PU-408/M, PU-700/M).* Bolted to the skid platform. Contains sledge hammer, fuel drum adapter, ground rods with clamps, cable slings and towing cable, ground wire and 3 ft. power cable extension (PU-700/M) (MERDC drawing 13214E1453).

n. *Portable Accessory Boxes (All Units).* One on each trailer and truck mounted generator set (MERDC drawings 132.4E1429 and 132.4E1455). Formerly contained BIIL items no longer supplied now furnished as an empty storage box.

o. *Shipping Weights and Dimensions.*

Item	length (in)	Width (in)	Height (in)	Volume (Cu ft.)	Weight (lbs.)
PU-407/M	171	96	87	827	7,500
PU-408/M	310	97	119	2,071	27,560
PU-699/M	171	96	87	626	8,700
PU-700/M	310	97	119	2,102	27,280

1-6. Description of Major Components

a. *Vehicles and Mounting Facilities.*

(1) *M200A1 trailer (PU-407/M, PU-699/M).* The generator trailer described in TM 9-

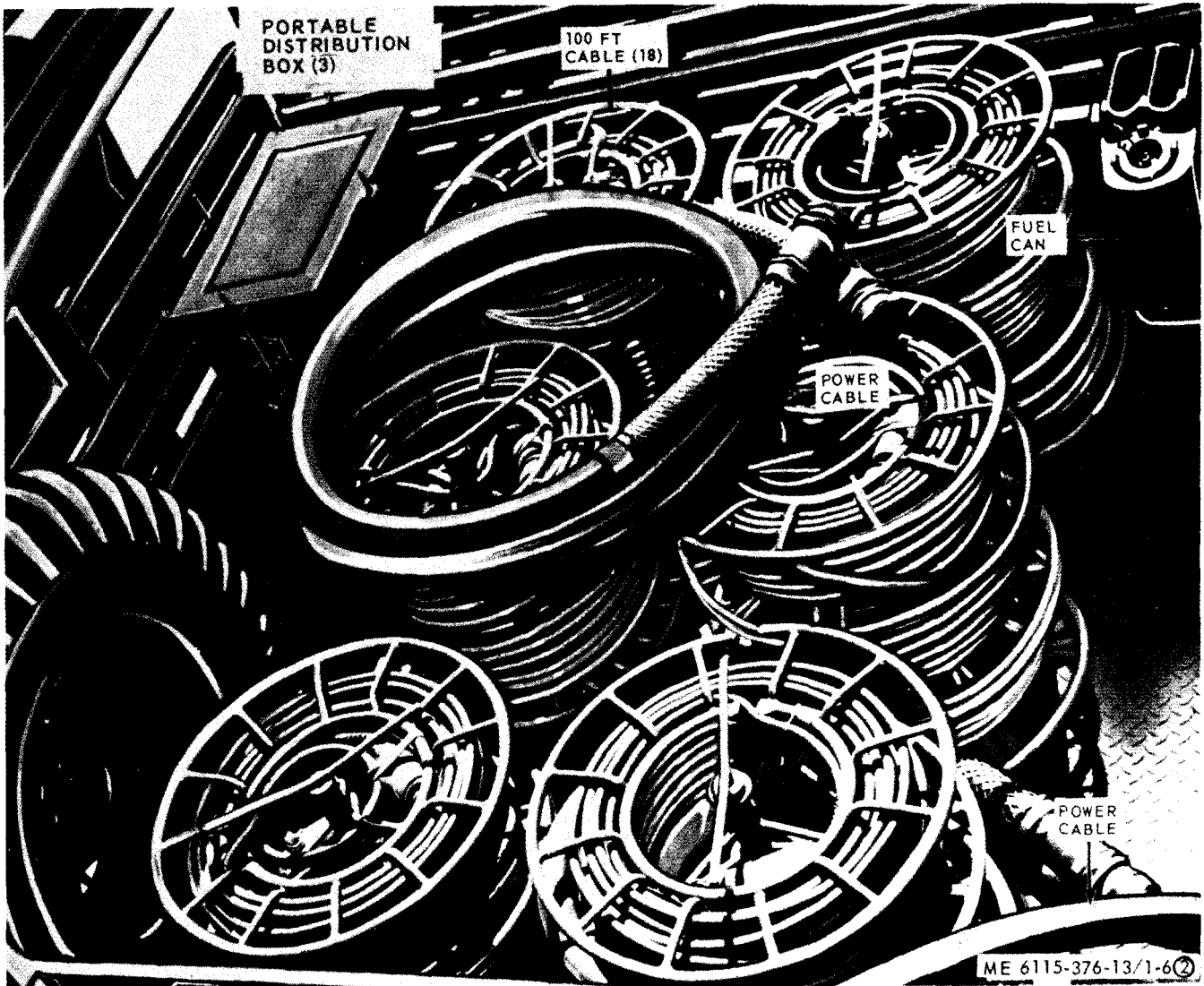

Figure 1-6. PU-408/M truck mounted Stewart-Stevenson DE Model 54400DE component location (sheet 2 of 2).

2330-205-205-14 has been modified for use with the 46 KW and 60 KW generator sets as follows:

(a) *Handbrake levers.* The two handbrake levers have been removed from under the generator trailer frame and mounted on the front step of the fender assembly (fig. 1-2(1)).

(b) *Blackout tail and stoplight.* The right rear blanket tail and stoplight assembly has been removed and relocated to the right of its original location (fig. 1-2 (2)).

(c) *Fender knit assembly.* The fender kit assembly (FSN 6115-705-4001) is fitted to the generator trailer frame and provides platform work area for personnel and mounting facility for power control and ancillary components (fig. 1-2 (1)).

(d) *Personnel Platform.* A retractable personnel platform is mounted at rear of the generator trailer frame, and provides access to control panel of the generator set (fig. 1-2(2)).

(e) *Rear landing leg assemblies.* Two landing legs are provided, one at each side of the rear channel of the frame (fig. 2-4).

(2) *Cargo truck (PU-408/M, PU-700/M).* The truck mounted generator sets use the M54A2 5-Ton 6x6 cargo truck as described in TM 9-2320-211-10, figures.

(3) *Skid platform (PU-408/M).* The skid platform (MERDC drawing 13214E1435) is a light-weight assembly 166 inches long, 84 inches wide and 8 inches high, weighing 2600 pounds. It provides mounting facilities for the diesel engine

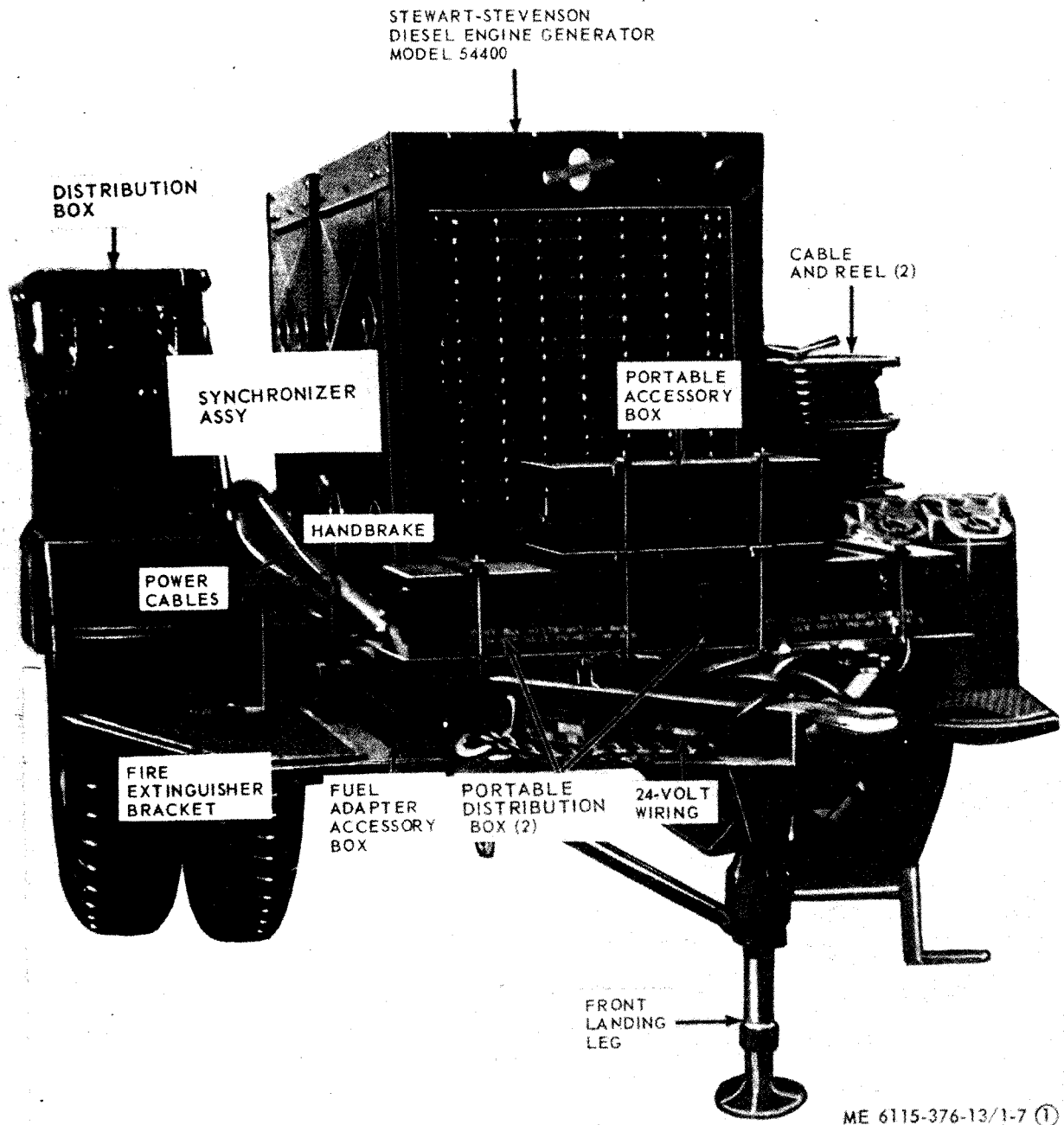

Figure 1-7. PU-407/M trailer with Stewart-Stevenson DE generator Model 54400 and synchronizer assembly (Sheet 1 of 2).

generator unit, distribution box, switchbox (or synchronizer assembly), portable distribution boxes, portable accessory box, power cables, extinguisher, and fuel cans. Lifting eye assemblies and hold-down assemblies are provided for removal, or replacement, and positioning of the skid platform in the body of the M54A2 truck. Towing eye assemblies are provided for towing the skid platform. (See fig. 1-6).

(4) Skid platform (PU-700/M). The skid

platform (MERDC drawing 13216E7558) is similar in construction, size, and purpose to that used in the PU-408/M listed in (3) above. It provides mounting facilities for components of the PU-700/M unit (fig. 1-8 (2)).

b. Power Generating and Distributing Components.

(1) Diesel engine generator set, 45 KW (PU-407/M, PU-408/M). The consolidated model 4070 diesel generator unit is described in TM 5-6115-

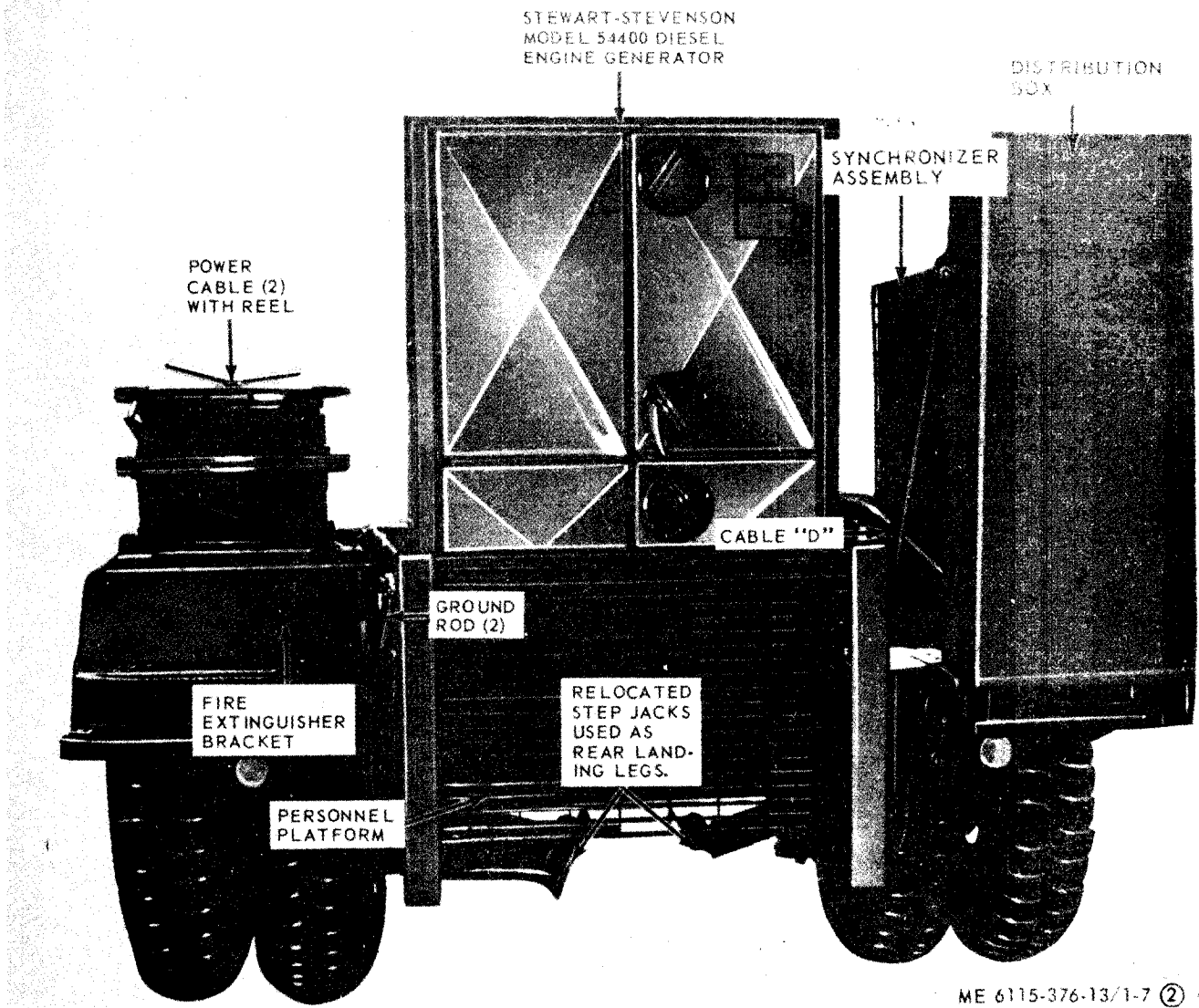

Figure 1-7. PU-407/M trailer with Stewart-Stevenson DE generator Model 54400 and synchronizer assembly (sheet 2 of 2).

239-10. It is connected for a four-wire output of 1.20 volt 3-phase, 60 hertz, and modified to allow entrance of a 45KW power cable (fig. 1-5).

(2) Diesel engine generator set, 45 KW (PU-407/M, PU-408/M). The Stewart-Stevenson Model 54400 diesel generator unit is described in TM 5-6115-247-15. It is connected for a four-wire output of 120/208 or 240/416 volt, 3-phase, 60 hertz, 45 KW (fig. 1-7).

(3) Diesel engine generator set, 60 KW (PU-699/M, PU-700/M). Refer to TM 5-6115-425-12 and -35 for operation and maintenance instructions for the 120/208-240/41.6 volt, 3-phase, 4-wire 50/60 hertz, liquid cooled skid mounted military design generator set model SF60-MD)/(CIED, FSN 6115-937-4388 (fig. 1-8).

(4) Distribution box (PU-407/M, PU-408/M). The military design distribution box is a weather-resistant cabinet 48-1/2 inches high, 13-1/2 inches wide and 12-1/2 inches deep, weighing 160 pounds. It contains a control panel and distribution panel and provides control and connecting facilities for distribution of power to area-type communications systems equipment. The control panel and distribution panel have folding side panels for weather protection. The control panel is hinged at the bottom to provide access to the wiring side of its component parts, and a backplate for access to rear of distribution panel components (fig. 1-9 and 1-10).

(5) Synchronizer Assembly (PU-407/M). This is military design, self-enclosed, portable box,



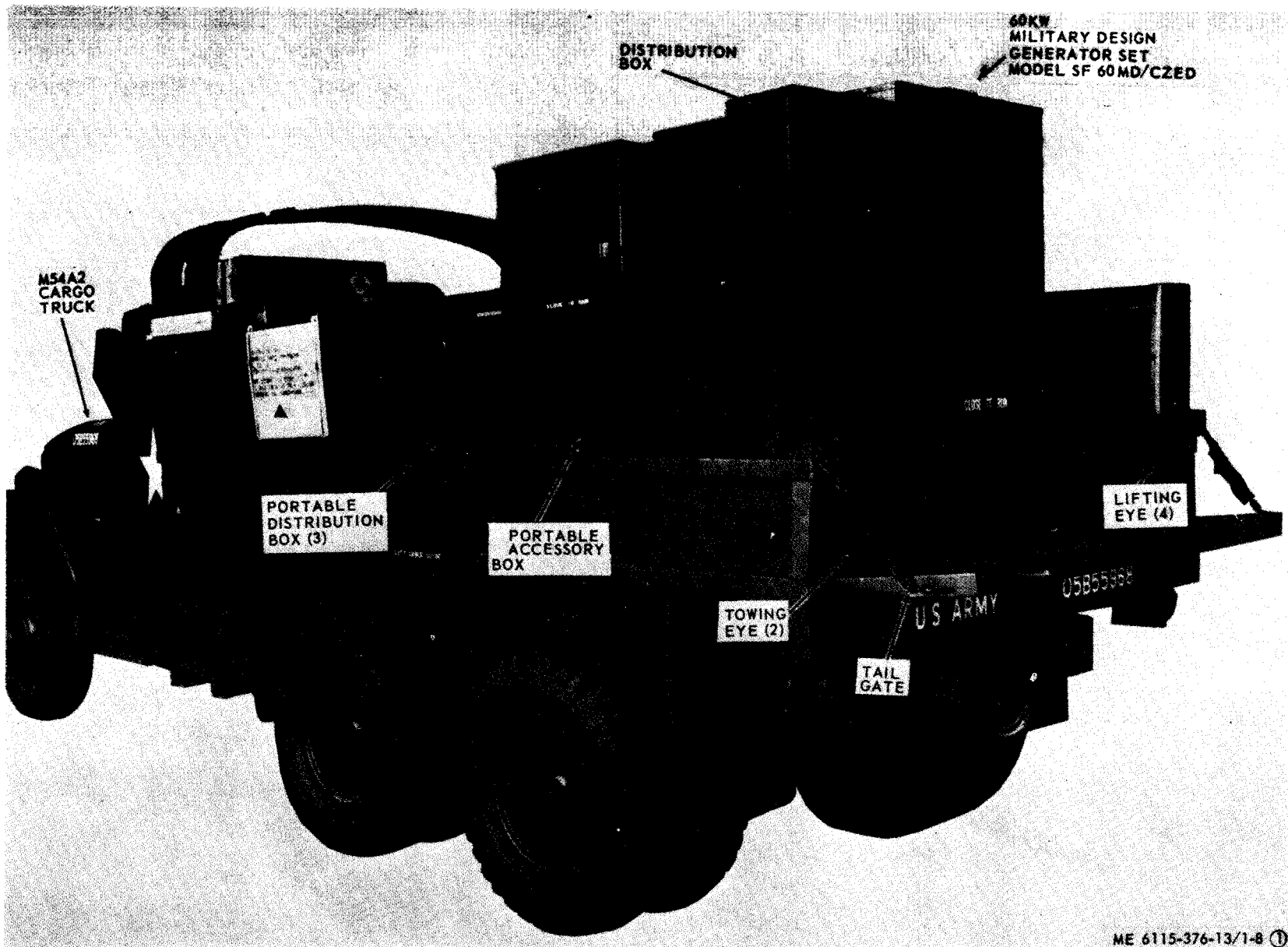
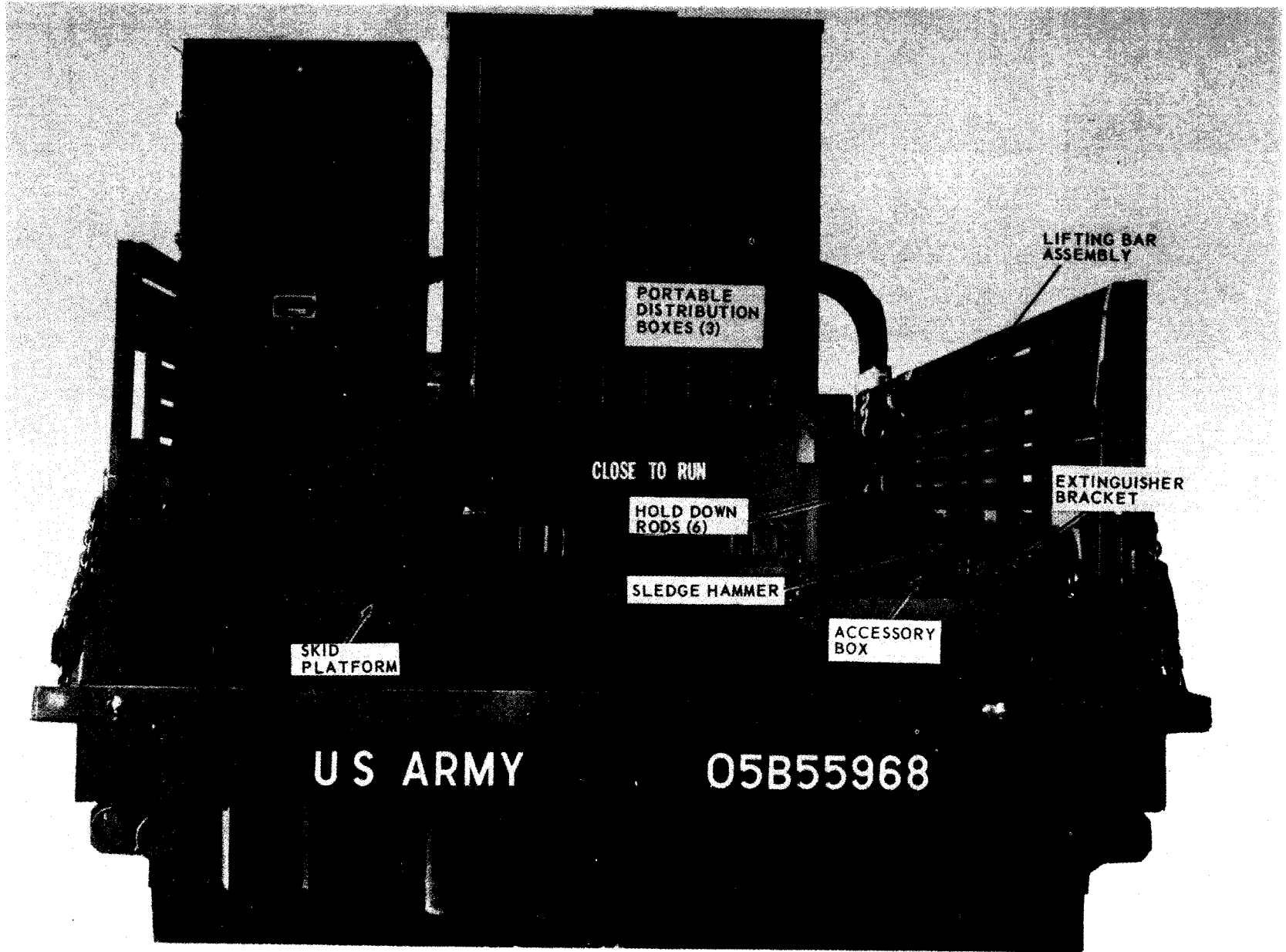

Figure 1-8. PU-700/M truck mounted Onan military design generator with distribution box and switchbox (sheet 1 of 2).



U S ARMY

05B55968

ME 6115-376-13/1-8 ②

Figure 1-8. PU-700/M truck mounted Onan military design generator with distribution box and switchbox (sheet 2 of 2).

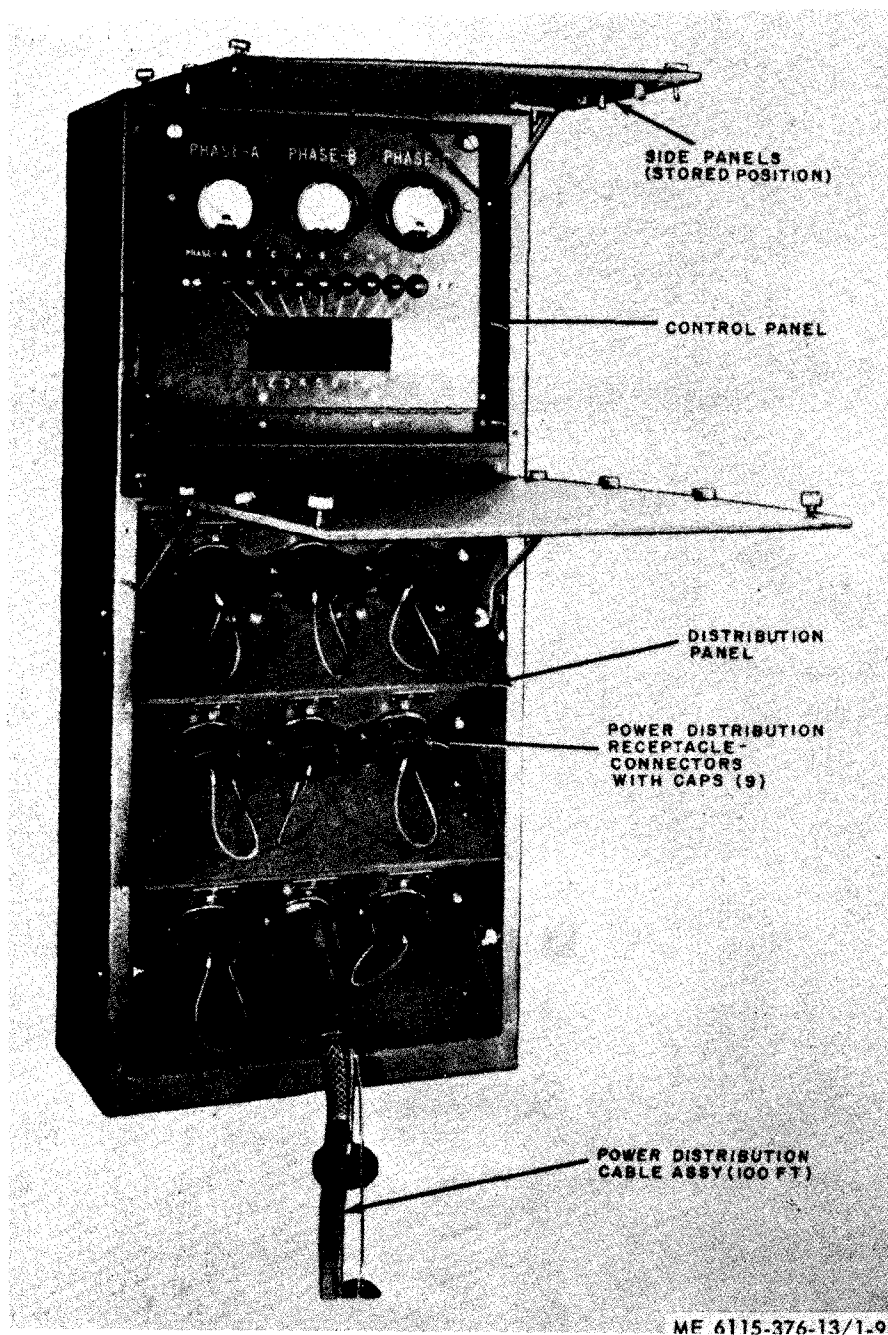

Figure 1-9. Distribution box, front (cover open). (PU-407/M, PU-408/M).

weather-resistant, which allows either one or two 45KW generators to be used separately or in parallel. It is 26-1/2 inches long, 16-7/8 inches wide, and 27 inches high, and weighs 231 pounds. The automatic switch consists of three contactors, an electromagnet consisting of a laminated clapper AC frame, hi-polar construction using two coils wired in series. Shading coils imbedded at coil faces of the magnet poles reduce inherent AC hum. The two solid synchronizer assemblies consist of three plug in type modules, two trans-

formers, silicon planar Epitaxial transistors, silicon diodes and capacitors.

(6) *Portable distribution boxes, (all units).* The portable distribution boxes (fig. 1-12) are 21 inches long, 12 inches wide and 12 inches deep. The weather-resistant case has a hinged cover with folding side panels for weather protection, and adjustable legs for operation in upright position. When connected to the distribution box, the portable distribution box provides 120 volt AC, single phase power for up to 12 connections. The

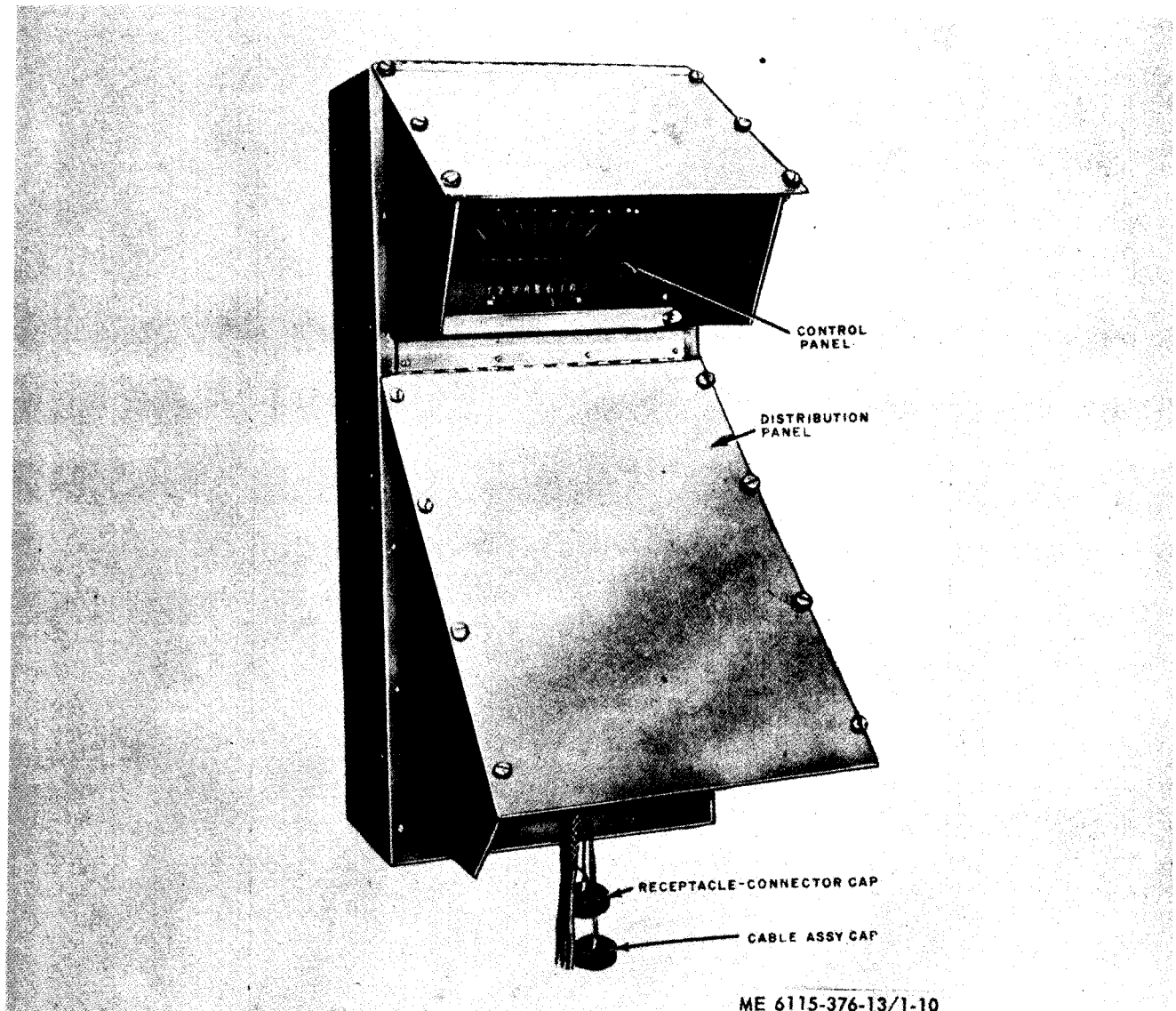

Figure 1-10. Distribution box, front (side panels in place). (PU-407/M, PU-408/M).

PU-407/M and PU-699/M have two portable distribution boxes; the PU 408/M has three, and the PU-700/M has six.

**1-7. Description of Minor Components**

*a. Sling Assembly (PU-408/M, PU-700/M).*

The sling assembly (fig. 1-13), consists of a lifting bar assembly, lifting bar cable, and four sling leg cables. The sling assembly is required when a lifting device is used to install the skid platform on the truck bed of the cargo truck.

*b. Towing Cable Assembly (PU-408/M, PU-700M).* The towing cable assembly (fig. 1-14) is used to tow the skid platform from the truck bed when an appropriate lifting device is not available. It may also be used wherever vehicular towing of the skid platform is required.

*c. Power Cable Assemblies, Reels, and Hold-down Rods.* The power cable assemblies are wound on light weight reels and secured by hold-down rods. There are two reels and one holddown rod on each trailer (PU-407/M and PU-699/M), and 18 reels, 6 holddown rods on each truck (PU-408/M, PU-700/M). Each cable assembly is 100 foot, 3 conductor cable with a waterproof power connector on each end. The power cable assemblies are used to connect or extend power to components within the area-type communications systems.

**NOTE**

Only the reels and holddown rods are furnished with the PU-407/M, PU-408/M, PU-699/M and PU-700/M. The 100-foot cables are user supplied.

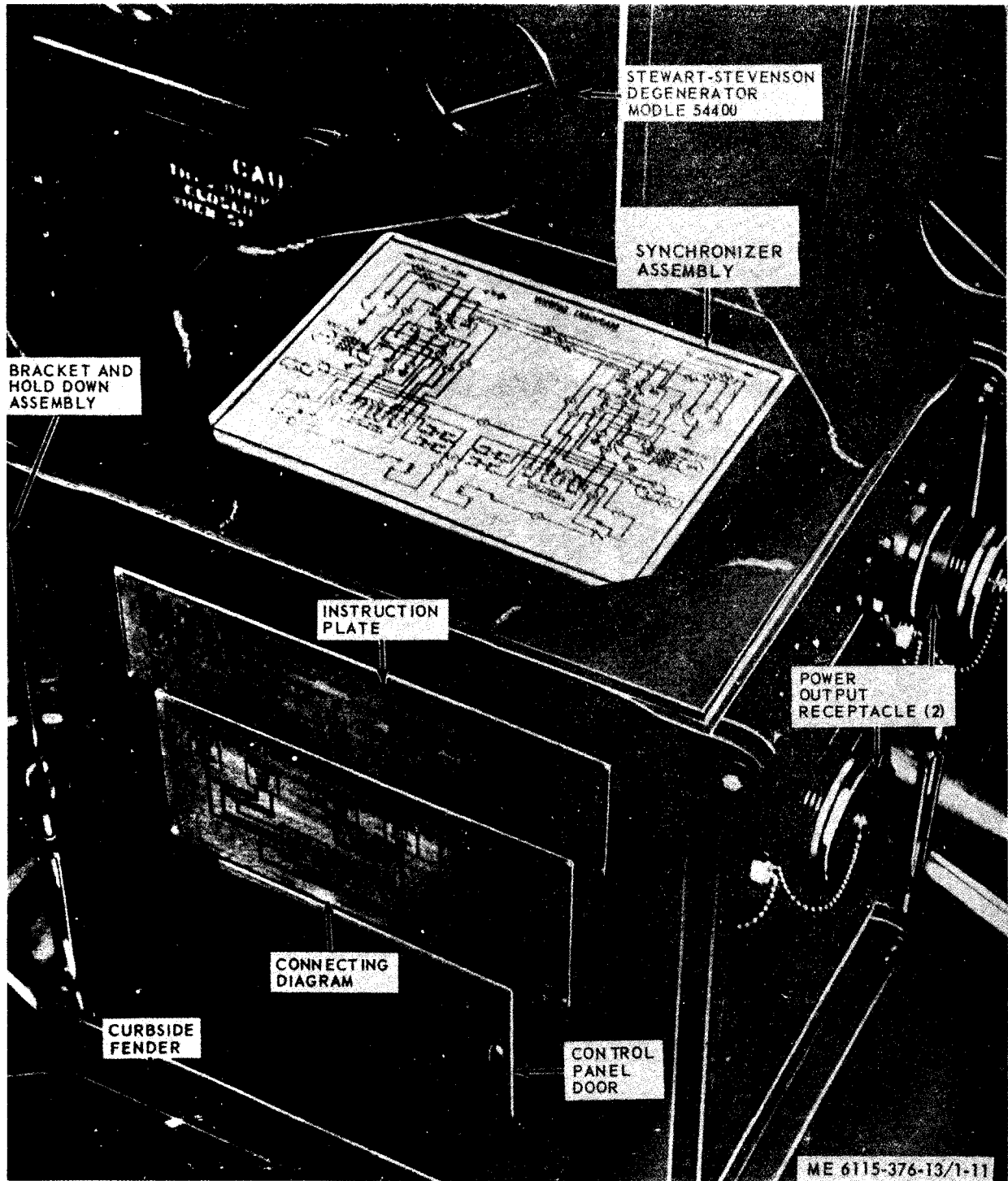

Figure 1-11. Synchronizer assembly (PU-407/M only).

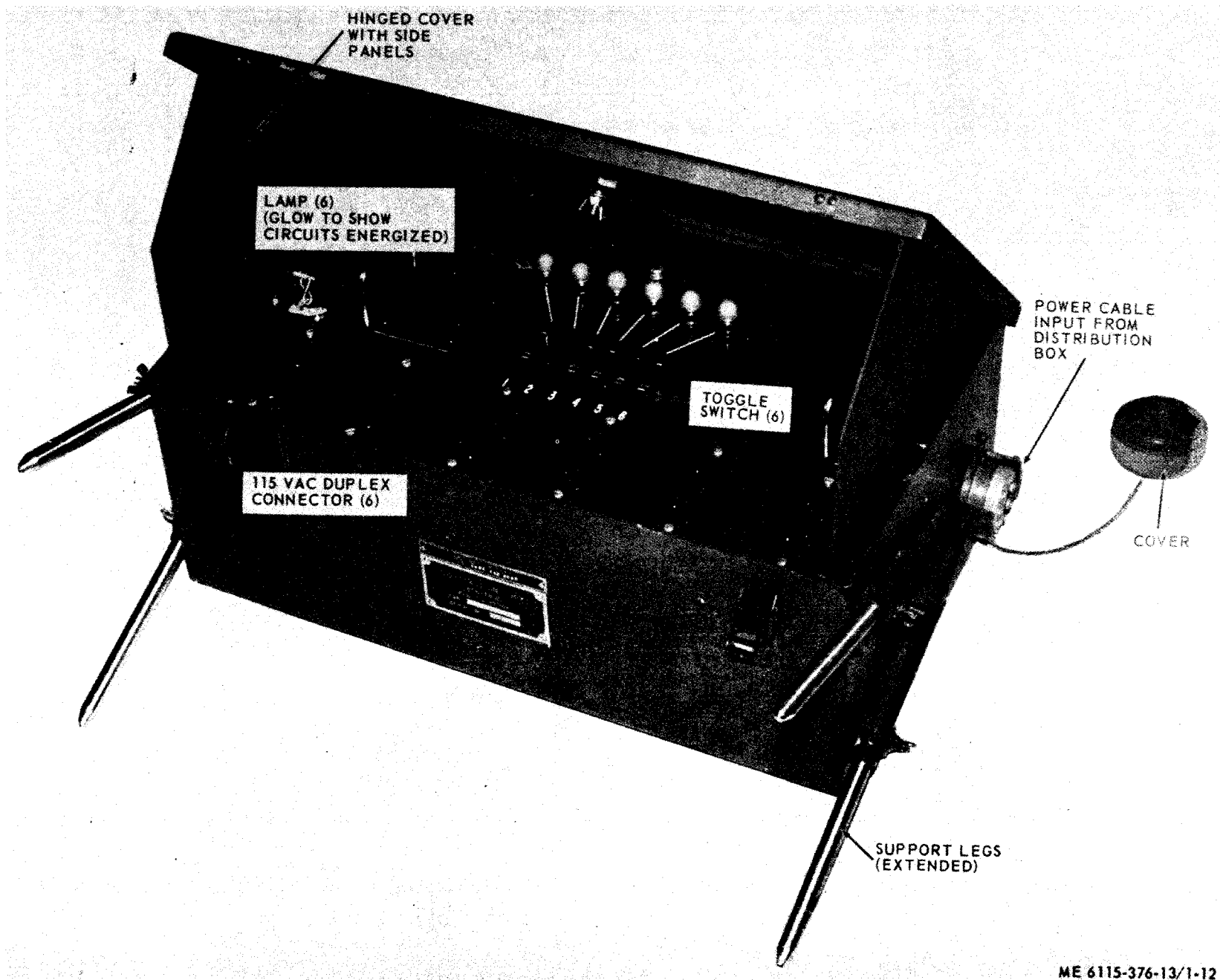

Figure 1-12. Portable distribution boxes (all units).

ME 6115-376-13/1-12

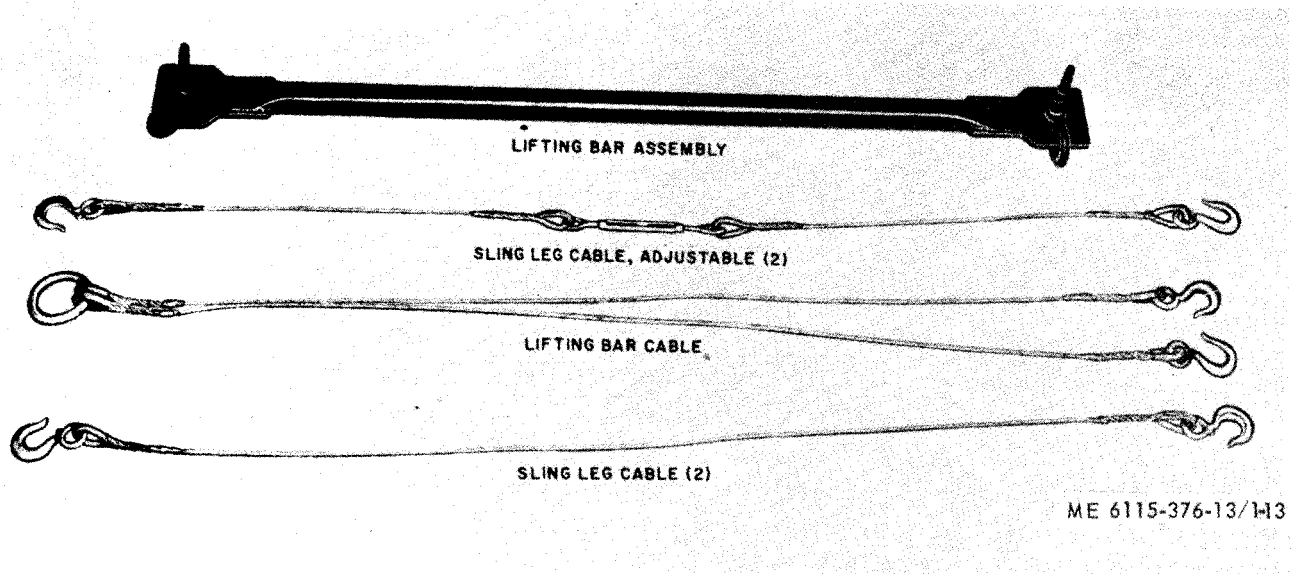

Figure 1-13. Sling assembly (PU-408/M, PU-700/M).

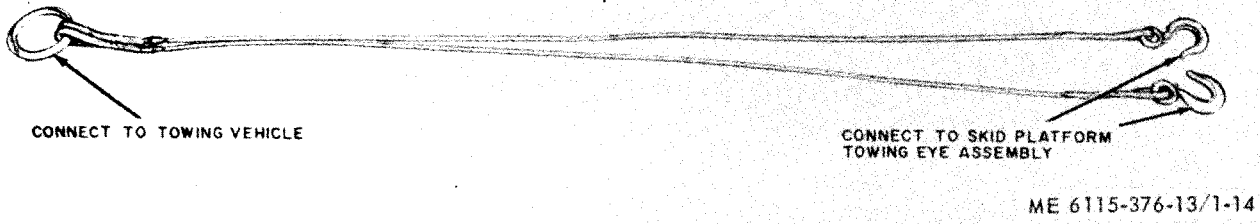
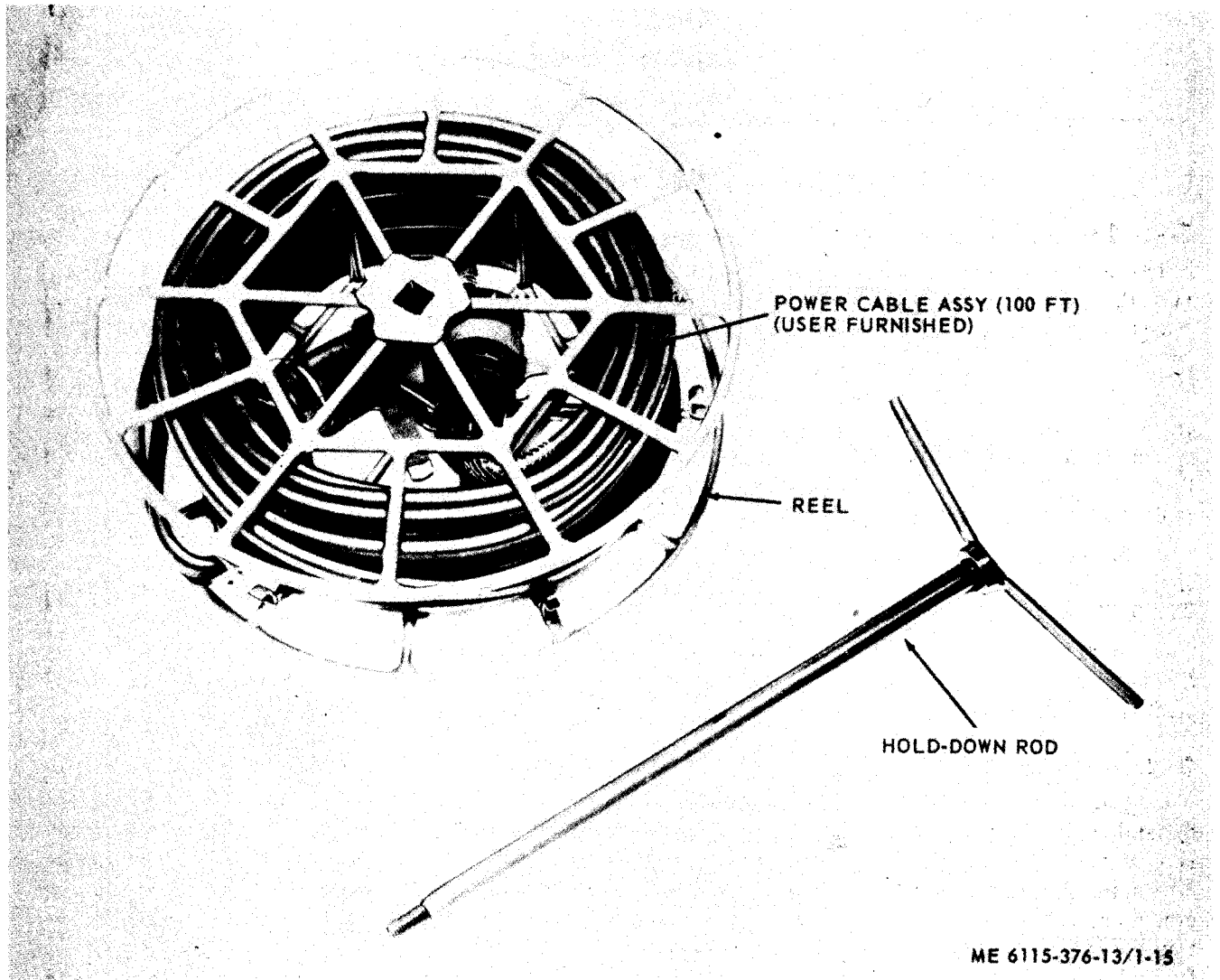

Figure 1-14. Towing cable assembly (PU-408/M, PU-700/M).



*Figure 1-15. Power cable, reel, and holddown rod, (all units).*



## CHAPTER 2

## OPERATING INSTRUCTIONS

## Section I. SERVICE UPON RECEIPT OF MATERIEL

## 2-1. Inspecting and Servicing Equipment

When a new or reconditioned generator set is received, perform the preventive maintenance checks and services (a, b, or c below) as appropriate,

a. *Diesel Engine Generator Set.* Perform the inspection and servicing procedures described in TM 5-6115-239-10 (Model 4070) or TM 5-6115-247-15 (Model 54400) for the 45KW units, or TM 5-6115-425-12 (60KW units).

b. *M54A2 Cargo Truck.* Perform preliminary service and break-in procedures as described in TM 9-2320-211-10.

c. *M200A1 Generator Trailer.* Perform preliminary service and break-in procedures as described in TM 9-2330-205-14.

## 2-2. Installation

a. *Siting.* Location of the generator sets will depend upon the tactical situation and local considerations. The site should be firm, dry ground with a maximum slope of 15 degrees. To minimize generator noise interference with the communication system and danger of fire due to presence of fuel oil, locate generator sets at the maximum distance from the communications system as allowed by the power cables (supplied by using command). By using additional 100-foot cables, this allows for an approximate distance of 200 to 300 feet between generator sets and the communications equipment.

b. *Installation of Generator Trailer (PU-407/M or PU-699/M).*

(1) Site generator trailer as described in a above.

(2) Unhook safety chains from towing vehicle and hook chains on trailer frame tiedown loops (fig. 2-1) .

(3) Close shutoff valves on service and emergency air lines at rear of towing vehicle. Uncouple inter vehicular lines from towing vehicle and fit the vehicle protective dummy couplings to vehicle air couplings. Fit the inter vehicular lines to dummy couplings on trailer frame.

(4) Remove connector of intervehicular 24-volt cable from towing vehicular receptacle and place it on trailer frame.

(5) Withdraw back brace lockpin (fig. 2-1) from back brace lockpin hole, and lower back brace assembly. Remove landing leg lockpin from landing leg storage bracket; lower landing leg to vertical position, and replace landing leg lockpin. Swing back brace assembly forward, aline lockpin holes of landing leg and back brace, and lock in place with the back brace lockpin. Rotate landing leg operating handle to extend landing leg inner tube and foot to the ground until trailer chassis weight is removed from pintle of towing vehicle. The height of trailer chassis lunette should be sufficient to allow for uncoupling from the towing vehicle.

(6) Remove lockpins holding rear landing legs in place. Drop legs to vertical position and replace lockpins. Unscrew inner tubes of rear landing legs until foot touches ground,

(7) Set trailer chassis handbrakes, unlatch towing vehicle pintle and drive vehicle forward and away from trailer chassis.

(8) Adjust length of front and rear landing leg assemblies until trailer chassis is level.

(9) Remove personnel platform locking bracket (fig. 1-2 (2)), remove lockpins, and lower rear personnel platform to operating position; replace lockpins.

c. *Installation of M54A2 Cargo Truck (PU-408/M, PU-700/M).*

(1) Site cargo truck as described in a above, parallel to and within approximately 15 feet of generator trailer, and with the two distribution boxes (fig. 1-1 ) adjacent to each other.

(2) Drop cargo truck tailgate and secure ladder to tailgate.

(3) Remove cargo truck tarpaulin and supporting bows. Store bows in brackets at front of truck, and store tarpaulin in a clean dry location.

## 2-3. External Fuel Line Connections

When the generator sets are to be operated for long intervals, frequent refilling of the fuel tanks

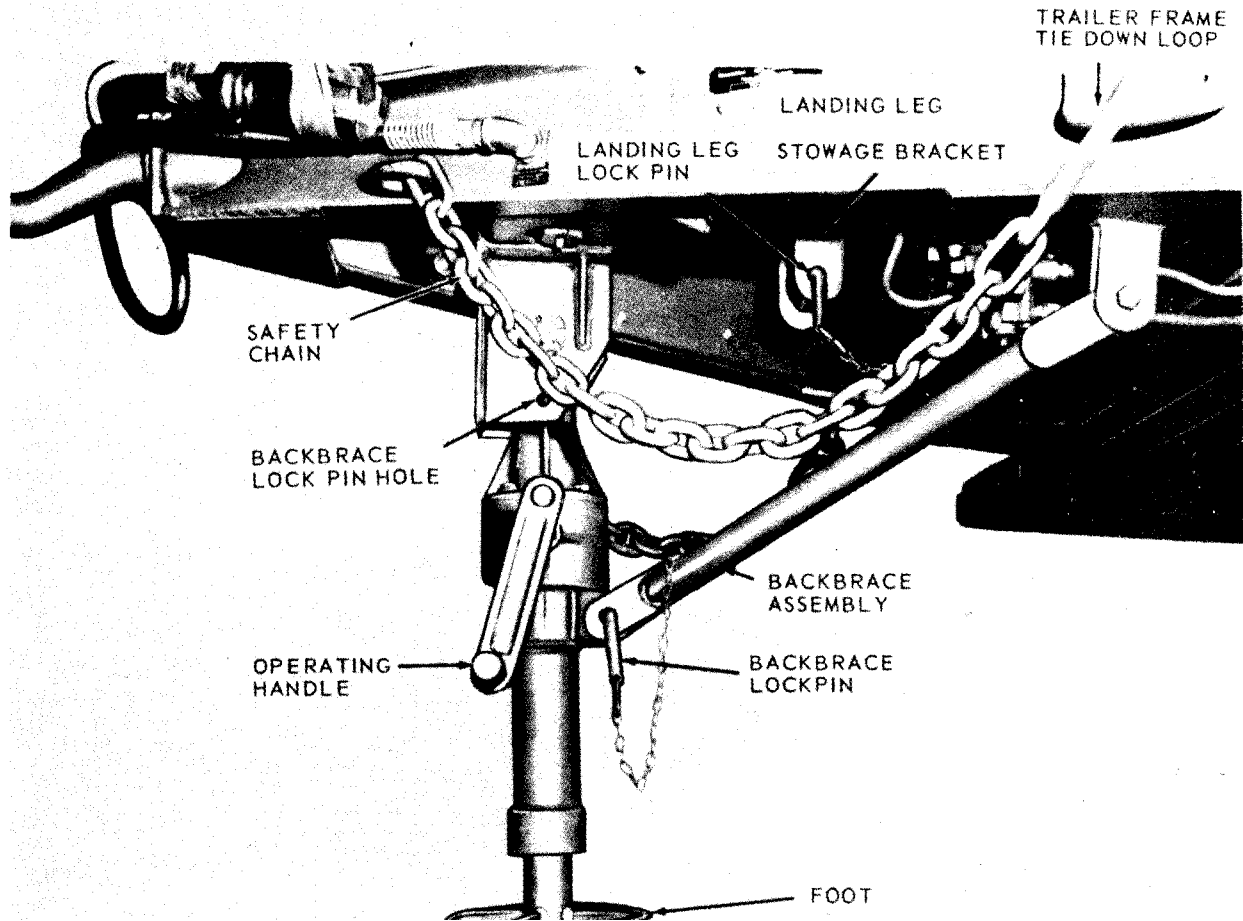

Figure 2-1. Generator trailer, front landing leg assembly (PU-407/M, PU-699/M).

can be eliminated by obtaining fuel from an external source (such as a 55-gallon diesel fuel drum). Connect external fuel source generator sets as follows:

a. Remove the 25-foot auxiliary fuel hose from the diesel engine generator unit tool box.

b. Remove fuel line adapter from accessory box of the PU-407/M (fig. 2-2) (or from the long accessory box of the PU-799/M).

c. Locate external fuel source approximately 15 feet from the generator set. Be sure that the external fuel source is located no lower or higher than 12 feet from base of diesel engine.

d. Insert auxiliary fuel hose through hose inlet located in skid base of diesel engine generator Unit.

e. Remove protective cap from hose coupling on engine three-way gate valve. Store cap in tool box.

f. Use an open end wrench to attach one end of fuel hose to engine gate valve.

g. Remove cap from top of 55-gallon fuel drum. Insert fuel line adapter through opening in top of drum. Press down on clamping lever to secure fuel line adapter in place.

h. Use an open end wrench to attach other end of fuel line to coupling on fuel line adapter.

i. Open engine gate valve, located at rear left side of diesel engine, to auxiliary.

#### 2-4. Ground Connections

##### WARNING

**All ground connections must be mechanically and electrically secure. A poor ground connection can cause injury or death to operating personnel.**

Each generator set is equipped with two 3-section ground rods, two 10-foot ground cables and clamps. Connect ground as follows.

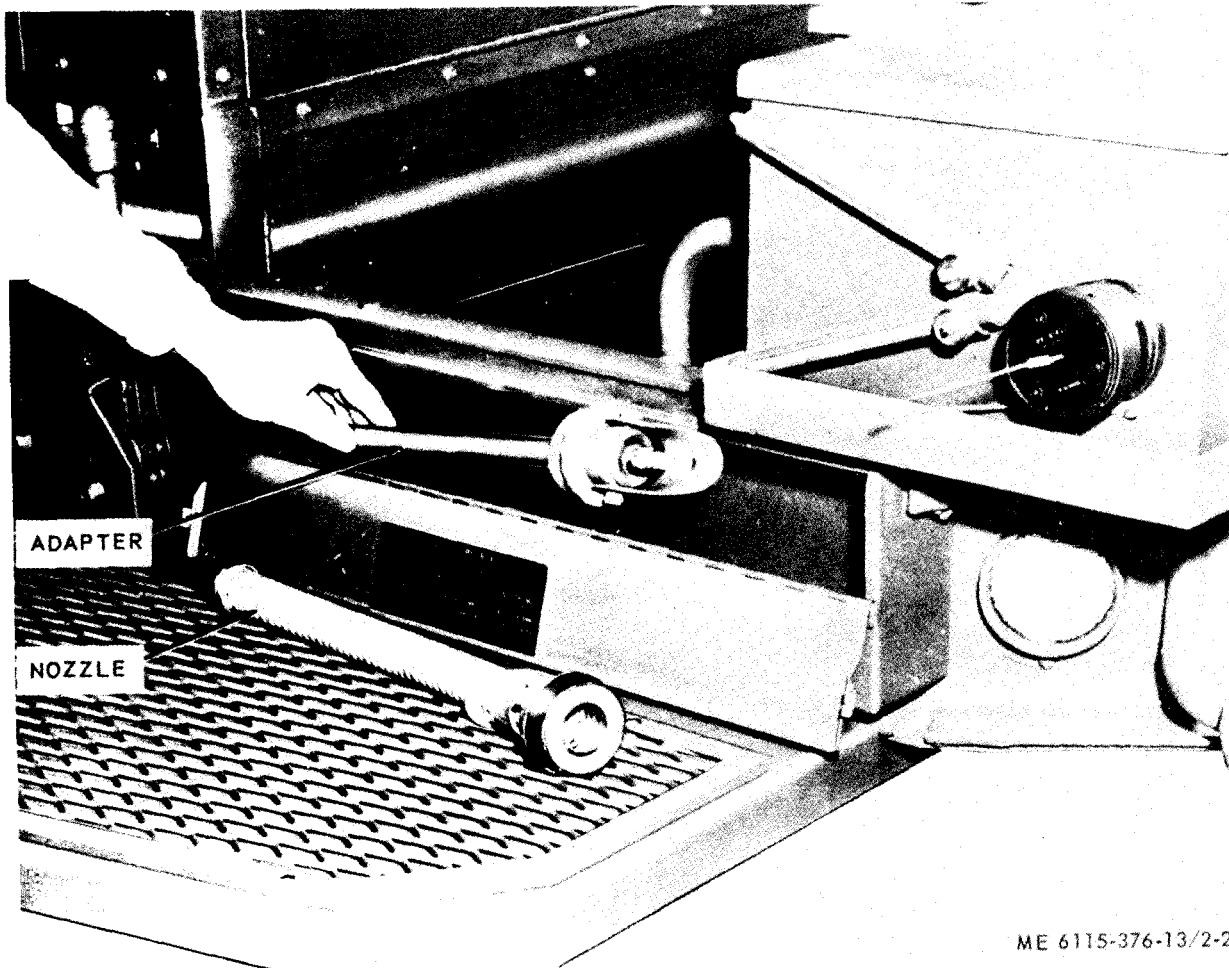

Figure 2-2. PU-407/M accessory box contents.

*a. Generator Trailer (PU-407/M, PU-699/M).*

(1) Remove a ground rod and sledge hammer from their holders.

(2) Drive ground rod into ground near roadside lunette end of trailer; leave approximately six inches of ground rod above ground.

(3) Remove a ground cable and clamp from the accessory box and fasten one end to the ground terminal located on trailer chassis roadside side rail.

(4) Connect loose end of ground cable to ground rod using the ground cable clamp.

*b. Cargo Truck Mounted Generator (PU-408/M, PU-700/M).* The cargo truck generator grounding procedures are similar to those for the trailer mounted generator, except for location of ground terminal. Connect ground cable with ground clamp, from ground rod to ground terminal at rear, curbside corner of skid platform. The ground rod should be close to the rear curbside wheels of the truck.

## 2-5. Primary-Standby Inter-Unit Connections

*a. 45 KW Units.* The PU-407/M and PU-408/M units are arranged for joint operation as a control power source as shown in figure 2-3, using the synchronizer assembly mounted on PU-407/M only.

*b. 60 KW Units.* The PU-699/M and PU-700/M units are arranged for joint operation as a control power source. With the switchbox (mounted on PU-699/M) unit selection as primary, standby or paralleling is automatically controlled by built in switching circuits (fig. 2-4).

## 2-6. Power Distribution Connections (45 KW)

Distribution of single-phase AC power is controlled by the distribution box control panel. The distribution box distribution panel provides nine receptacle-connectors for distribution of single phase AC power to area-type communication

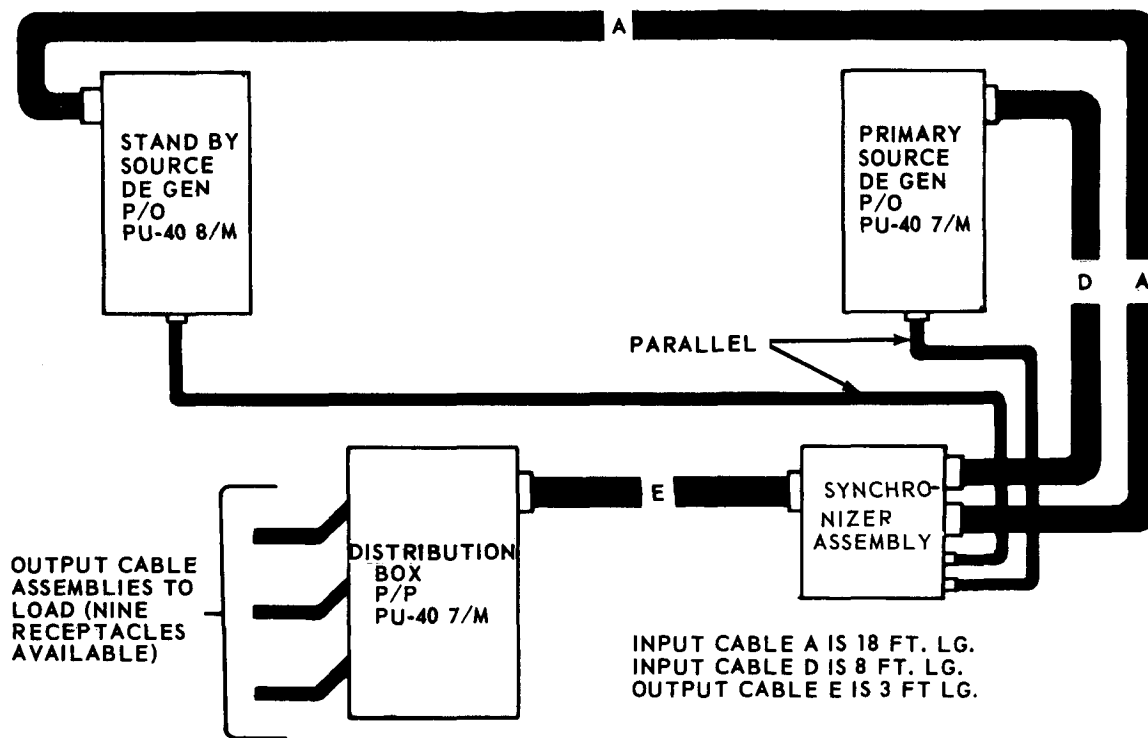

ME 6115-376-13/2-3

Figure 2-3. Inter-unit cabling diagram with synchronizer assembly (PU-407/M, PU-408/M).

equipment shelters (a below), and to the portable distribution boxes (b below). The nine distribution panel receptacle connectors are divided into three groups, phase A, B, and C. Connect required number of 100 foot power cables between distribution panel and communications shelters and/or portable distribution boxes in such a manner as to divide total current drain as equally as possible between the three phases.

a. Shelters.

(1) Remove required number of 100-foot power cables (user supplied) and reels from stored position by unscrewing and removing holddown rods.

(2) Connect one end of each power cable to distribution panel receptacle-connectors in numerical order as indicated on the distribution panel.

(3) Connect other end of power cable to power access receptacle of communications shelter. If the 100-foot power cable is too short, use additional 100-foot cables to increase overall power cable length.

b. Portable Distribution Boxes. The portable distribution boxes are connected with 100-foot power cables to the distribution panel (fig. 1-1) of the trailer and truck, and from the portable distribution boxes to individual equipments requiring single phase 60 Hertz AC power.

2-7. Power Distribution Connections (60 KW)

Distribution of single-phase AC power is controlled by the distribution panel assembly of the PU-699/M and PU-700/M. These distribution panel assemblies both provide nine receptacle-connectors for distribution of single-phase AC power to area-type communications equipment shelters (as in para 2-6a), and to the portable distribution boxes (para 2-6b ). The nine receptacle-connectors are divided into three groups (phases A, B and C). Connect required number of 100-foot power cables (user supplied) between distribution panels and communications shelters, and/or portable distribution boxes in such a manner as to divide total current drain as equally as possible between the three phases.

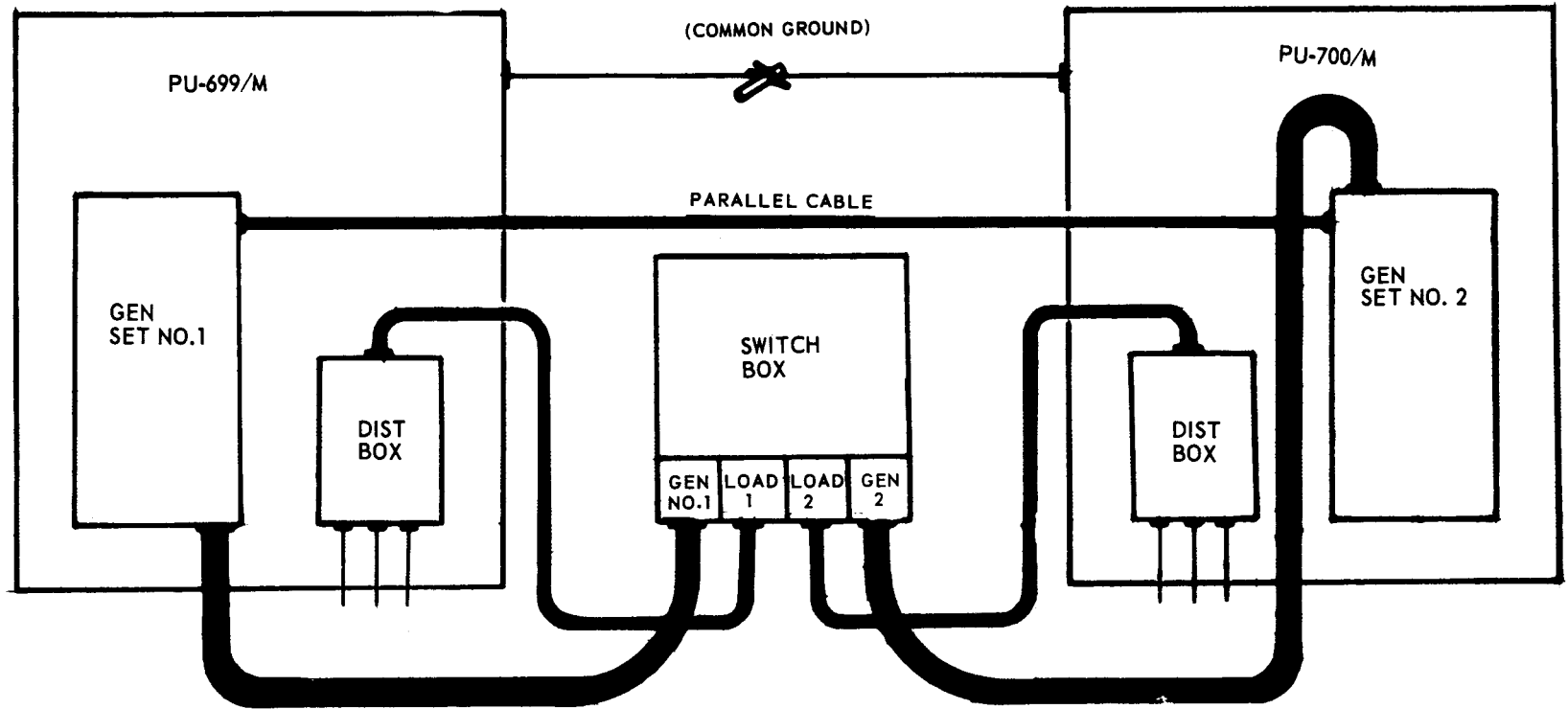

NOTE: CABLING FROM  
DISTRIBUTION BOXES  
TO EQUIPMENT IS  
USER SUPPLIED

ME 6115-376-13/2-4

Figure 2-4. Inter-unit cabling diagram. PU-699/M, PU-700/M.

**Section II. MOVEMENT TO NEW WORKSITE**

**2-8. Dismantling for Movement**

Stop all units, disconnect power cables between units; wind the 100-foot power cables on their reels, and store reels in travel position (2 on PU-407/M and PU-699/M, 18 on PU-408/M and PU-700/M). Disconnect ground rods and auxiliary fuel drums (if used). Close up distribution panel assemblies, DE hoods, and reinstall switchbox on fender of PU-699/M (or synchronizer assembly on fender of PU-407/M ). Store portable accessory boxes, fuel cans, and portable distribution boxes in place on trailer and truck. Hook the PU-407/M to rear hitch of PU-408/M truck (or

PU-699/M trailer to PU-700/M truck). Place front and rear landing legs of trailer sets in stored position, and ladder in place on truck. Attach air and electric lines between trailer and truck, close truck tailgate.

**2-9. Reinstallation After Movement**

Following movement, separate trailer and truck and site both units (para 2-2), Set up ground connections (para 2-4) and external fuel lines (para 2-3). Make connections required between sets, panels and auxiliary facilities (para 2-5 through 2-7).

**Section III. CONTROLS AND INSTRUMENTS**

**2-10. General**

This section describes the various controls and instruments, and provides the operator/crew sufficient information to insure proper operations of the two generator sets.

**2-11. Controls and Instruments**

The following are descriptions and functions of the controls, indicators, and connection points of the power distribution components of the trailer mounted (PU-407/M or PU-699/M) or truck mounted (PU-408/M or PU-700/M ) generator sets. For information concerning controls and instruments on the diesel engine generator units, refer to TM 5-6115-239-10 (Consolidated Model 4070, 45KW) or to TM 5-6115-247-15 (Stewart-Stevenson Model 54400, 45KW). For the 60KW sets refer to TM 5-6115-425-23. For information on the M54A2 cargo truck refer to TM 9-2320-211-10; and for information on the M200A1 generator trailer refer to TM 9-2330-205-14. Figure 2-5 shows a typical control panel set up. (Model 4070 shown; other models have similar controls),

**a. Distribution Box (All Units).** The descriptions and functions listed below apply to controls, indicators, and receptacle connectors associated with all three output phases (A, B, and C) of the distribution box of the PU-407/M and PU-408/M, The distribution box, distribution panel, and control panel used with the 60KW PU-699-M and PU-700/M is similar, differences being in com-

ponents and their location, Refer to figure 2-6 for the PU-407/M setup ready for operation,

<i>Control, Indicator, or Connector</i>	<i>Function</i>
Phase meters, one per phase, ___	Indicate total phase current drain of the three (PU-407/M and PU-408/M) associated single phase 0-500 amps (PU-699/M and PU-700/M).
Phase control switches _ _	Provide on-off contact and overload protection for associated single phase power circuits.
(circuit breaker switches with 70-amp rating, 3 per phase).	
Phase indicator lamps _____	Glow when associated phase circuit breaker switch is operated to on position.
(neon lamps 110 VAC, 3 per phase).	
Phase receptacle-connector ____	Provide for connection of output power cables to single phase power circuits.
(power receptacle-connector, 3 per phase).	

**b. Portable Distribution Boxes (AU Units).**

<i>Control, Indicator, or Connector</i>	<i>Functions</i>
Control switches (circuit breaker switches, 15-amp rating).	Provide on-off control and overload protection for associated power receptacle (No. 1 through No. *).
Indicator lamps (neon, 110 VAC).	Glow when associated control switch is operated to On position.
Output receptacles (Duplex power receptacles, 110 VAC).	Provide for connection or power cords from additional or special equipment
Input Receptacle Connectors---	Provide for connection of power cable from distribution box.

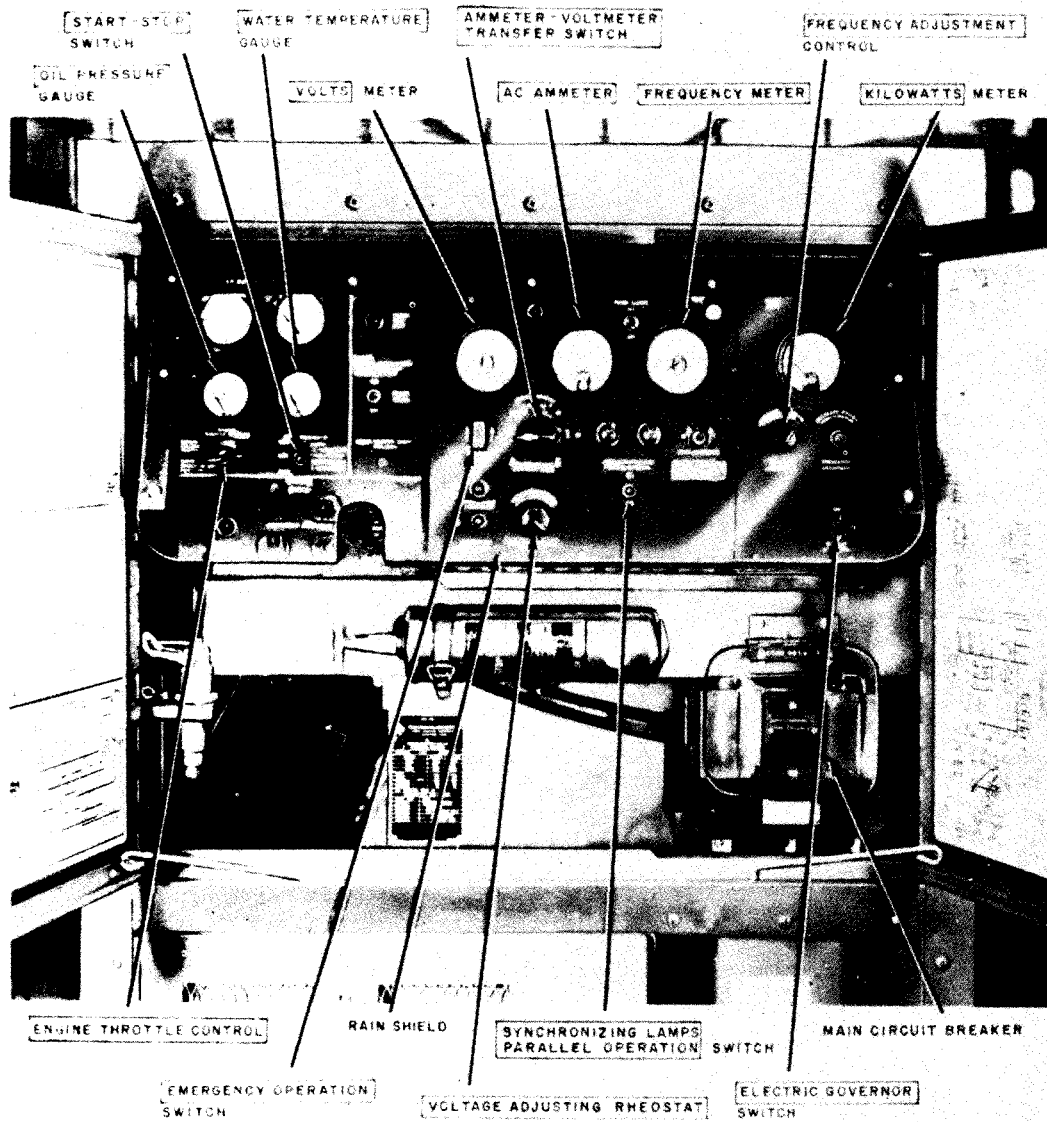

ME 6115-376-13/2-5

Figure 2-5. DE generator set, showing typical controls and instruments.

c. Synchronizer Assembly (PU-407/M Only).

(1) Controls.

<i>Control, Indicator, or Connector</i>	<i>Function</i>
Safety circuit breaker light, -..	Indicates application of power to load cable interconnecting receptacle.
Safety circuit breaker 3-pole, ---	Connects load cable interconnecting switch box and power output receptacles.
Power input receptacle, -----	Provides facilities for inter-connecting generator unit cable and synchronizer assembly.
Power output receptacle, -----	Provides facilities for interconnecting operating power to system requiring 60 hertz power.

<i>Control, Indicator, or Connector</i>	<i>Function</i>
Synchronizing switch, -----	Controls action of the single pole, single throw toggle switch
Synchronizing bypass switch, ---	Momentarily removes holding voltage from solenoid of control relay K2 to enable magnetic contactor S3 and auxiliary relay K1 to close.
Parallel cable power unit -----	Provides facilities for interconnecting generator unit to synchronizer assembly through the parallel cables.

(2) Theory of synchronizer assembly operation. When power is applied to the synchronizer

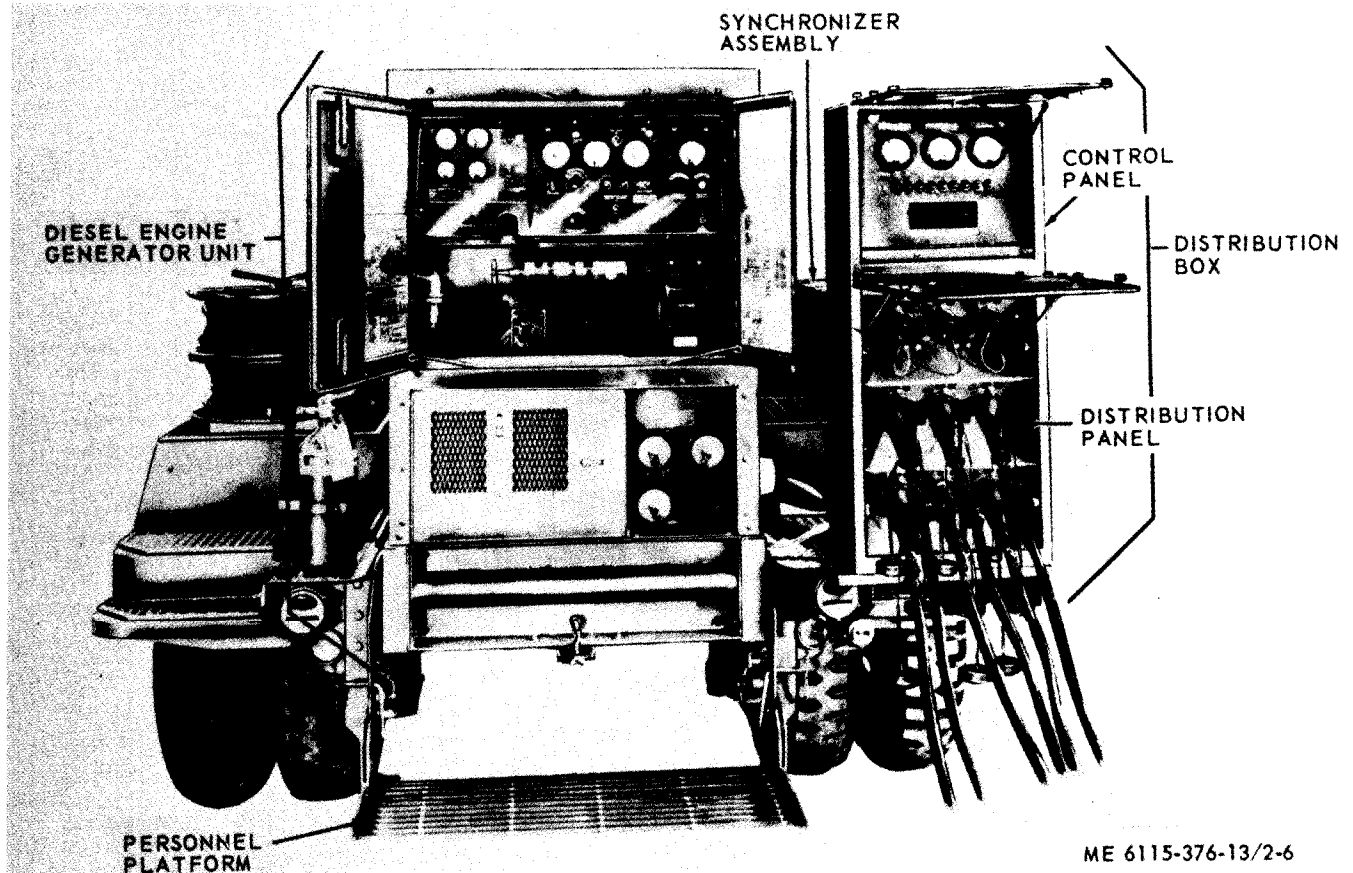

Figure 2-6. Trailer mounted DE generator set PU-407/M, ready for operation.

assembly through power input receptacle, voltage is applied through synchronizing bypass switch S2, across terminals 6 and 7 of terminal load TB1, across resistor R2, through transformer T1, rectifiers CR1 through CR4, and resistor capacitor (RC) network consisting of resistor R3 and capacitor C1, and is applied to the solenoid of control relay K2, as shown in figure 2-8. When power is applied to the synchronizer assembly through load cable interconnecting switchbox (the synchronizer assembly) receptacle, 3-phase power is applied through safety circuit breaker CB1 and power output receptacle to load cable. A voltage is also applied across terminals 1 and 2 of terminal board TB1, across resistor R1 through transformer T1, rectifiers CR1 through CR4, and RC network R3 and C1, to solenoid of control relay K2 and safety circuit breaker. Light DS1 glows to indicate presence of power at load cable interconnecting switch box receptacle (or synchronizer assembly).

(3) *Magnetic contractors S3.* When power is applied to the synchronizer assembly through power input receptacle ((2) above), magnetic

contactor S3 must be actuated to complete a current through power output receptacle or load cable interconnecting switchbox receptacle to the load. This is accomplished by the following:

(a) When power is applied to load through power input and power output receptacle from a single power source, synchronizing switch S1 is closed to apply power to one side of the solenoid of magnetic contactor S3 and auxiliary relay K1. The solenoid current is completed through contacts 3 and 4 of de-energized control relay K2. Control relay K2 is deenergized by activating synchronizing by-pass switch S2. When auxiliary relay K1 is energized, one pair of contacts completes the governor current (c below) of the diesel engine generator sets and the other set of contacts short contacts 3 and 4 of control relay K2. When synchronizing by-pass switch S2 is released, contacts of auxiliary relay K1 hold auxiliary relay K1 and magnetic contactor S3 energized.

(b) When power is applied to load through power input, the load cable interconnecting switchbox, and power output receptacles from two power sources, the electronic synchronizer assem-



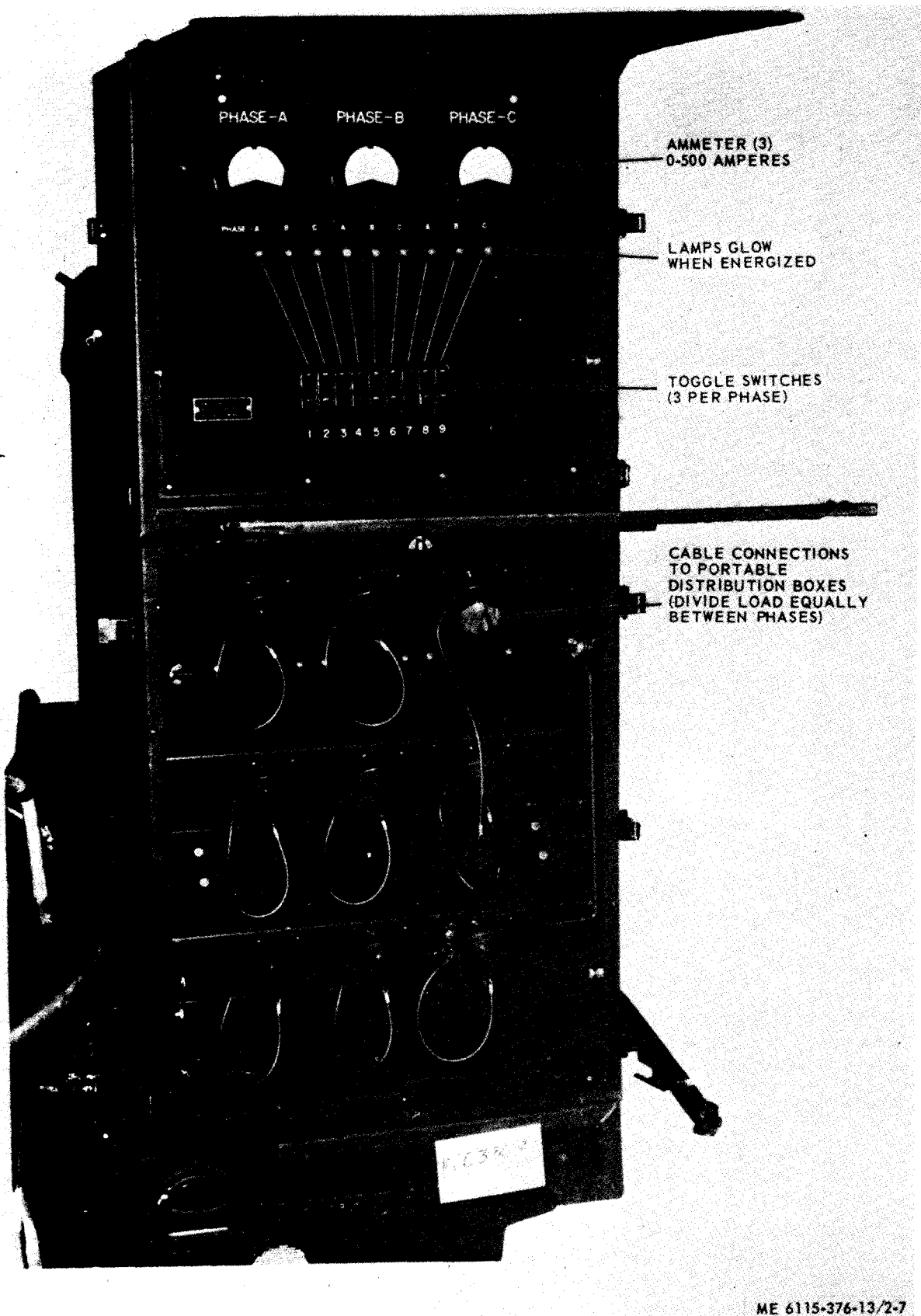
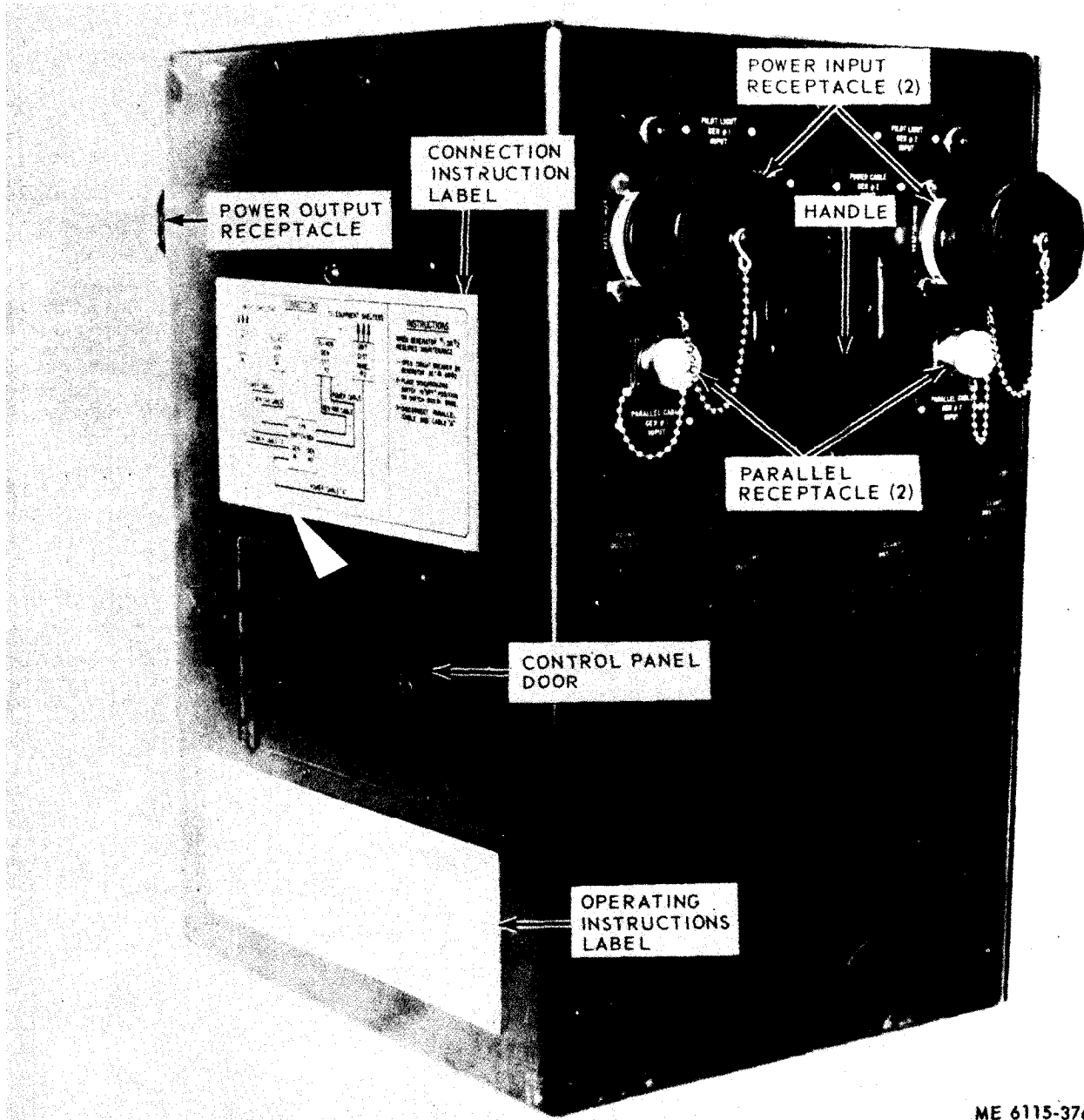

Figure 2-7. Distribution box controls (PU-699/M, PU-700/M).



ME 6115-376-13/2-8

Figure 2-8. Synchronizer assembly controls indicators and instruments.

bly (fig. 2-9), compares voltage, phase and frequency of the two power sources and applies resultant dc voltage to solenoid of control relay K2. When input power sources are equal in voltage, frequency, and phase and synchronizing switch S1 is in on position, auxiliary relay K1 and magnetic contactor S3 are energized, and power is applied to load from both power sources.

(c) When two power sources are paralled ((b) above), auxiliary relay K1 connects the electric governor circuit series. This arrangement maintains required equal voltage output from

both power sources.

d. *Switch box (PU-699/M only)*. This is a military design used on the trailer mounted 60KW generator set. Unit selection as primary, standby or parallel operation entirely automatic. Contains switches for applying power to Gen No. 1, Load 1, Load 2 and Gen No. 2. Applies power from generator (s) to distribution box (es) for distribution to the portable distribution boxes to supply single-phase 60 hertz, 115 volt AC current to components of an area-type communication system (fig. 2-8).

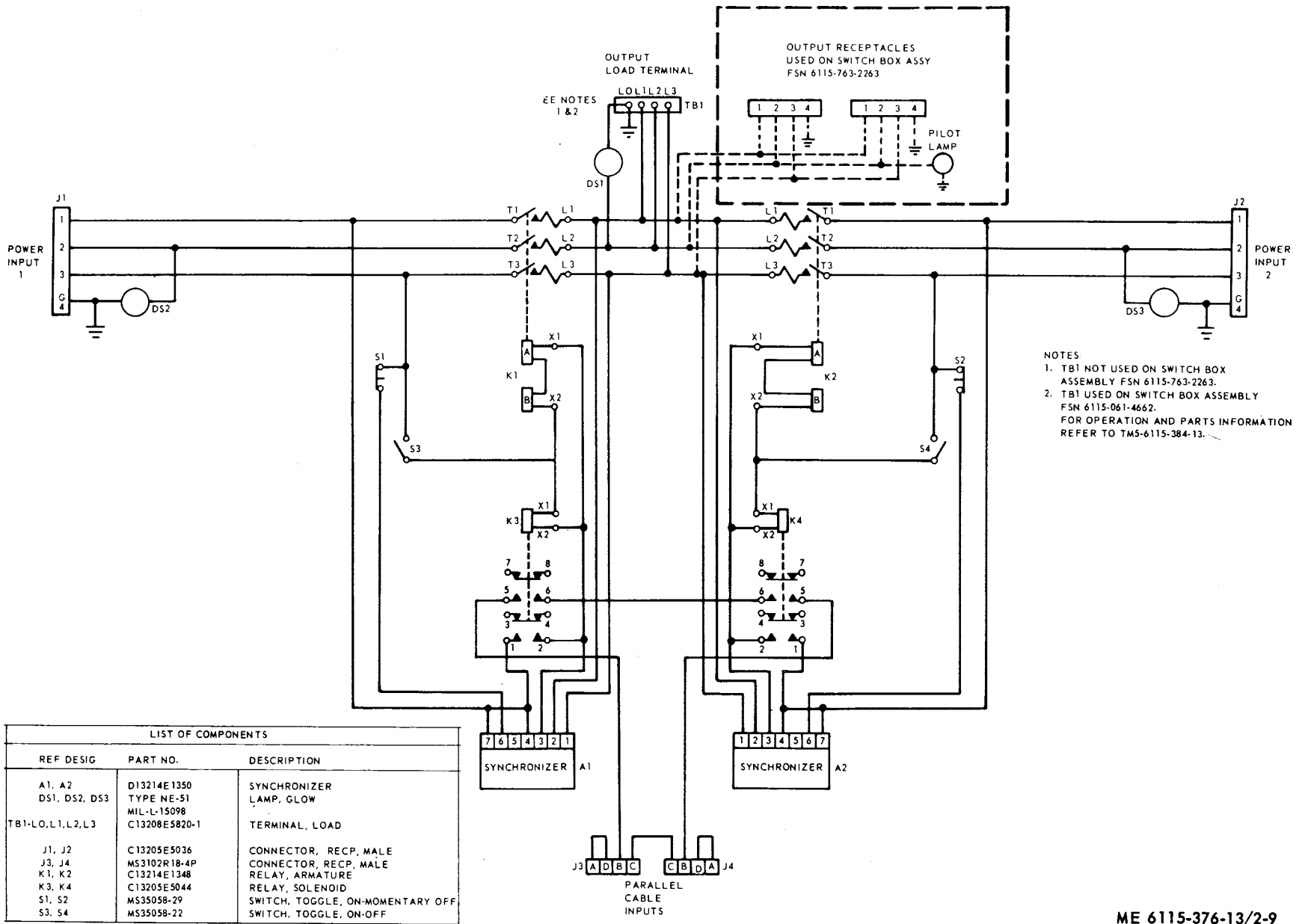

Figure 2-9. Wiring diagram of synchronizer assembly.

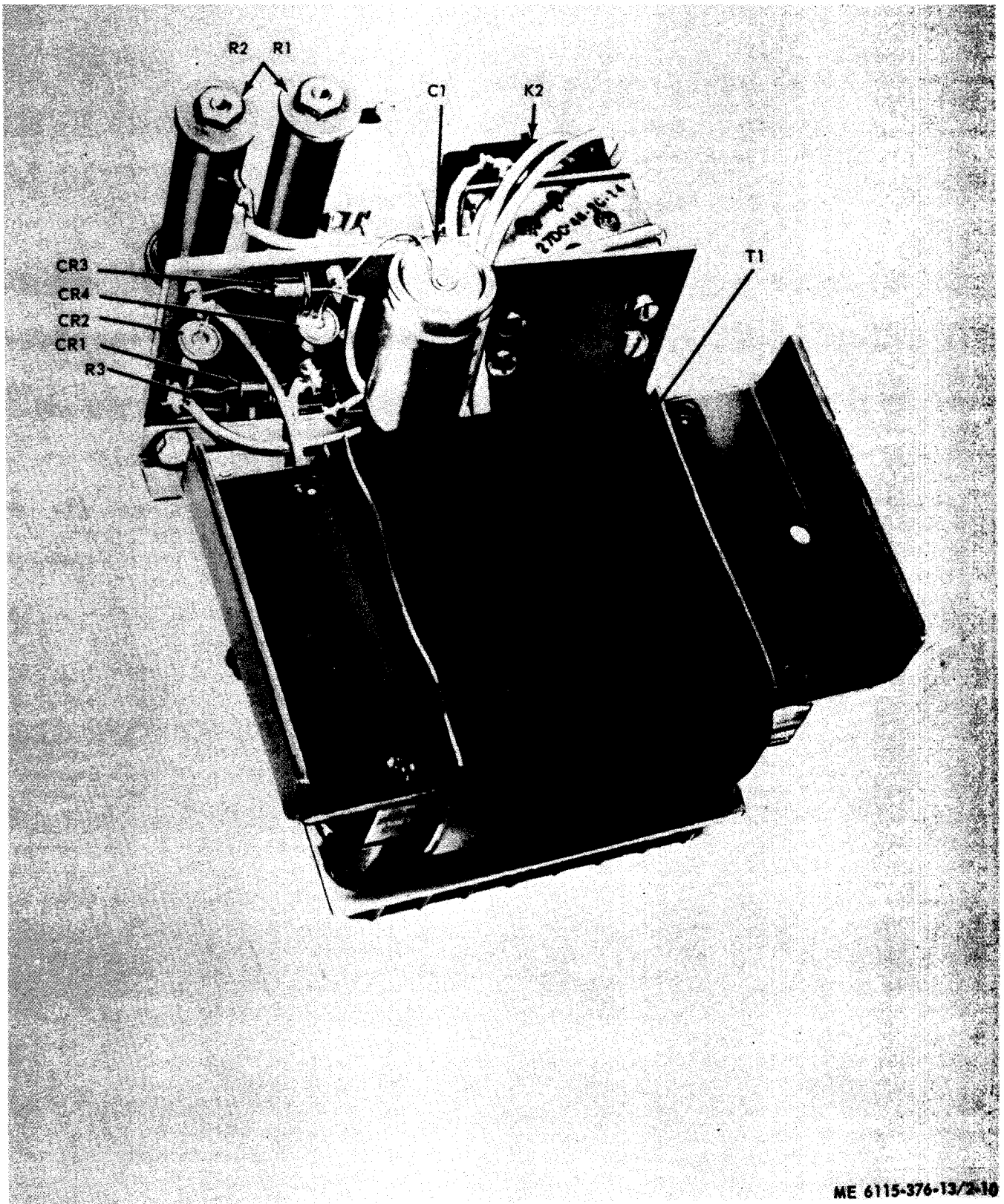

Figure 2-10. Electronic synchronizer, location of parts.

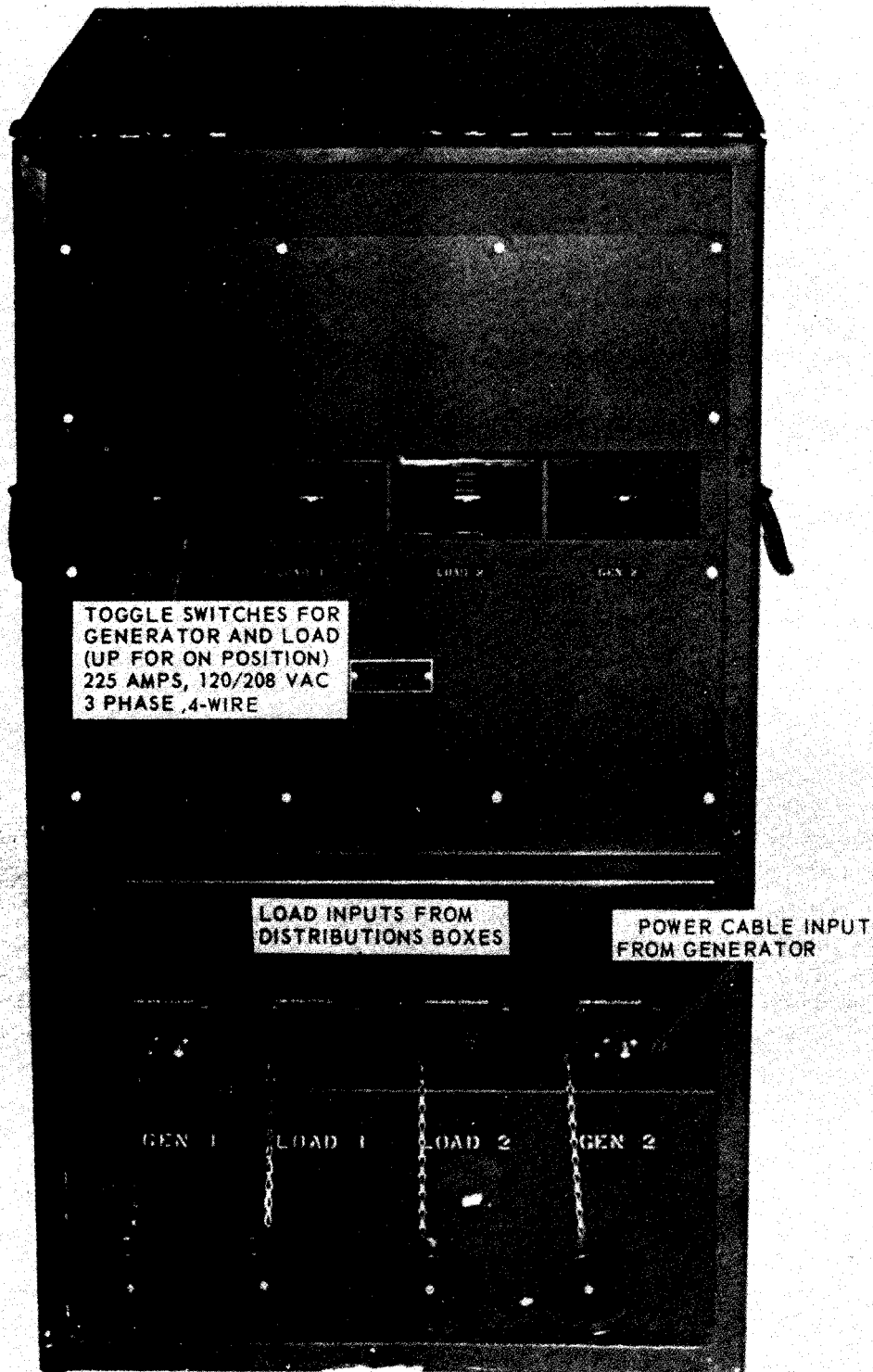

Figure 2-11. Switch box controls (PU-699/M).

## Section IV. OPERATION UNDER USUAL CONDITIONS

### 2-12. General

*a.* The instructions in this section are for the information and guidance of personnel responsible for operations of the generator sets,

*b.* The operator must know how to perform every operation which the generator sets are capable of. This section contains instructions on starting and stopping the generator sets, on operation of the generator sets, and on coordinating the basic motions to perform the specific task for which the equipment is designed. Since nearly every job presents a different problem the operator may have to vary given procedures to fit the individual job.

### 2-13. Preoperational Inspection

The following inspections are to be performed daily by the equipment operator prior to starting the diesel engine generating unit,

*a. Visual Inspection.* Inspect equipment for obvious defects such as missing components; oil, fuel, and cooling system leaks; missing or loose hardware items; bent or cracked cases and housings; broken or missing lamps, and defective fan belts. Report all leaks, bent or cracked cases and housings and defective fan belts to organizational maintenance; correct other deficiencies,

*b. Fire Extinguishers.* Inspect fire extinguishers and mountings for obvious defects and date of last inspection. Replace if corroded, damaged, empty or outdated.

*c. Fuel.* Check fuel supplies and replenish as necessary. Check fuel filter cap and strainer for dirt or insecure mounting, check filler cap gasket for damage and replace if necessary. Replace strainer and filler cap if necessary.

*d. Fuel Filters.* Remove filter drain plug and drain water and sediment from secondary fuel filter (see TM 5-6115-239-10 or TM 5-6115-247-15 for 45KW units, or TM 5-6115-425-12 for 60KW units), and remove drain plug. Remove secondary fuel filter vent plug, operate fuel primer pump until fuel runs out in a clean, solid stream; replace vent plug, Inspect heater assembly fuel tank, replenish as necessary.

*e. Radiator.* Inspect for damage. Inspect coolant for rust, dirt, and oil; replace if rusty or dirty. Report an oily condition to organizational maintenance.

*f. Batteries.* Clean batteries and battery box assembly, check battery connections, and electrolyte level. Report defective batteries, cables and connections to organizational maintenance. Maintain electrolyte level to 3/8-inch above battery plates.

*g. Lubrication.* Lubricate diesel engine generator sets as prescribed by current L.O. (TM S-6115-239-10 or TM 5-6115-247-15 for 45KW sets; TM 5-61 15-425-12 for 60 KW sets). Check for damaged grease fittings and filler caps; report damage to organizational maintenance. Refer to current L.O. of TM 9-2320-211-10 for M54A2 truck and to TM 9-2330-205-14 for M200A1 trailer lubrication,

*h. Power Cables.* Check to see that all power cables are properly connected. Inspect for damaged insulation and connectors; replace as necessary.

*i. Controls and Instruments.* Inspect controls and instruments for damage and loose mountings. Be sure circuit breakers are in OFF position. Report damage to organizational maintenance; correct other deficiencies,

### 2-14. Starting

*a. Preparation for Starting (Fig. 2-5).*

- (1) Perform preoperational inspections (para 2-13).
- (2) Position engine gate valve (left side of diesel) to position corresponding with fuel source.
- (3) Prime fuel system (*b* below) if required.
- (4) Turn voltage adjusting rheostat to maximum counterclockwise.
- (5) Place electric governor switch and synchronizing lamps parallel operation switch to off.
- (6) Turn frequency adjustment control maximum counterclockwise.
- (7) Open diesel engine generator door assemblies.

#### CAUTION

**The diesel engine generator unit must not be operated unless the screen backing door located at back of fuel tank access door is open. During inclement weather, side panels rainshields must be in place and screen backing door and control panel door must be open**

- (8) Pull out engine throttle control one inch and lock in place.

(9) Depress overspeed switch button located at rear of diesel engine generator unit (accessible through generator assembly, left or right door assemblies).

**b. Primary Fuel System.**

(1) Remove vent plug from top of secondary fuel filter (accessible through diesel engine left door).

(2) Operate fuel primer pump until no air bubbles emerge from filter assembly air vent.

(3) Replace vent plug in top of secondary fuel filter.

(4) For new or rebuilt equipment, operate fuel primer pump to pump fuel into dry tank for initial operation.

**CAUTION**

**Never prime day tank by pouring fuel directly into tank; no filter is provided between day tank and injection pump.**

**c. Starting Diesel Engine.**

(1) Depress and hold start and stop switch at start until oil pressure gage reaches 10 pounds per square inch and diesel engine starts. Release start and stop switch to run.

**CAUTION**

**Do not hold start and stop switch at start over 30 seconds without allowing a 3-minute cooling period. If diesel engine does not start after a few attempts, perform the preoperational inspections (para 2-13) and procedures in a above before reporting malfunctions to organizational maintenance.**

(2) Allow diesel engine to run at a constant speed (a (8) above) until water temperature gage indicates between 110° and 110°F.

**d. Energizing Generator Assembly.**

(1) Perform procedures, given in c above.

(2) Momentarily place field flashing switch located below frequency meter (fig. 2-6) in upward position.

**CAUTION**

**If AC volts meter does not indicate a voltage buildup, the diesel engine is not up to rated speed, unlock engine throttle control, push in slightly, lock in place, and repeat procedure given in (2) above. Never place field flashing switch in upward position for longer than a few seconds, and never after generator has been energized.**

(3) Turn frequency adjustment control to midposition,

(4) Place electric governor switch to on,

(5) Unlock engine throttle control, push it in against control panel and lock in place.

(6) Adjust voltage adjusting rheostat for diesel voltage indication on volts meter.

(7) Adjust frequency adjustment control for diesel frequency indication on frequency meter.

**2-15. Stopping**

**NOTE**

To turn generator set off in an emergency, operate emergency operation switch (fig. 2-5).

**a. Normal Stopping.**

(1) Disconnect individual loads by placing associated distribution panel circuit breaker at OFF.

(2) Disconnect overall load by placing the operating diesel engine unit main circuit breaker (fig. 2-5) at OFF.

(3) Pull engine throttle control out one inch and allow diesel engine to run at a steady speed for three minutes.

(4) Place electric governor switch to off,

(5) Place start and stop switch to stop.

**NOTE**

If unit is not to be run for a period of 12 hours, or is to be transported, turn the three-way engine gate valve to off, and close diesel engine generator unit door assemblies.

**b. Automatic Stopping.** Safety devices stop the diesel engine generator unit in event of low oil pressure, high coolant temperature, and diesel engine overspeed. If the diesel engine generator unit is stopped automatically by a safety device, perform procedures given in paragraphs 2-13, 2-14, and 2-15. If the diesel engine generator unit continues to stop automatically, notify organizational maintenance.

**2-16 Operation of Equipment**

**a. Normal Operating Procedures With Synchronizer Assembly (PU-407/M).**

(1) Insure that input power cable from both generator sets and both parallel roller are properly installed.

(2) Lift load terminal cover and connect load cables to power cable output terminals of synchronizer assembly (fig. 1-11).

(3) Start generators (para 2-14) and run at a fast idle until engines are warmed to proper operating temperature; given to required RPMs then check voltage and cycles.

(4) Close circuit breakers on both generator sets.

(5) Open control panel door (fig. 1-11) and position synchronizing toggle switches to ON (fig. 2-11).

(6) Press by-pass toggle switches down. Both sets now operating are parallel and share the load. (Adjust frequency meters of both generator sets for same frequency, if necessary).

(7) To stop operation, turn synchronizing switches to OFF; open circuit breaker on control panel of generators, and stop generator sets as given in paragraph 2-15. If halt is to be lengthy, remove load cables, parallel cables, and power cables, and install dust covers.

(8) Perform only maintenance checks and services outlined in applicable generator manual (TM 5-6115-239-10 or TM 5-6115-247-15 for 45KW; TM 5-6115-425-12 for 60KW units).

*b. Normal Operating Procedures With Switch Box (PU-699/M).*

(1) Connect power cable from generator set No. 1 (PU-699/M) to Gen 1 of switch box.

(2) Connect power cable from bottom rear of distribution box of PU-699/M to Load 1 of switchbox.

(3) Connect power cable from generator set No. 2 (PU-700/M) to Gen 2 of switchbox.

(4) Connect cable from bottom of distribution box of PU-700/M to Load 2 of switchbox.

(5) Connect a parallel cable from parallel connector of PU-699/M to same socket of PU-700/M.

(6) Connect common ground to both generator sets.

**NOTE**

*These five cables are the only cables furnished with the PU-699/M and PU-700/M. Reels for 100-foot cables are furnished but cabling must be supplied by using command. There are 18 reels and 6 holddown rods with the PU-700/M; 2 reels and 1 holddown rods supplied with the PU-699/M. To supply power (115 VAC, single phase, 60 hertz) to equipment, proceed with steps (7) through (9).*

(7) Connect one end of a cable from one of the 100-foot reels to a connection on distribution panel to the distribution box on either PU-699/M or PU-700/M.

(8) Connect other end of cable to power input connector of a portable distribution box (6 supplied with PU-700/M, 2 with PU-699/M).

(9) Connect 115 volt, 2 prong connector from one of the 6 connectors of the portable distribution box, to the equipment requiring 115 VAC single phase power.

**CAUTION**

**When making connections to distribution boxes be sure to divide total load equally between generator sets**

**Section V. OPERATION UNDER UNUSUAL CONDITIONS**

**2-17. PU407/M and PU408/M**

For information on operation and maintenance of the diesel engine generator sets (45KW) under adverse weather conditions refer to TM 5-6115-239-10 (Model 4070) or TM 5-6115-247-15 (Model 54400).

**2-18. PU-699/M and PU-700/M**

For information on operation and maintenance of the 60KW diesel engine generator sets under adverse weather conditions refer to TM 5-6115-425-12,

**Section VI. OPERATION OF MATERIEL USED IN CONJUNCTION WITH THE EQUIPMENT**

**2-19. Fire Extinguishers**

For information on use and maintenance of fire extinguishers in the 45KW generator sets refer to TM 5-6115-239-10 (Model 4070) or TM 5-6115-247-15 (Model 54400) or to TM 5-6115-425-12 on 60KW units.

**2-20. Cold Weather Starting Aids, Winterization Kits and Heaters**

Refer to TM 5-6115-239-10 or TM 5-6115-247-1.5 (45KW) or TM 5-6115-425-12 (60KW) for information on use and maintenance of cold weather starting aids, winterization kits, and heaters.



## CHAPTER 3

## OPERATOR'S MAINTENANCE INSTRUCTIONS

## Section 1. BASIC ISSUE ITEMS

**3-1. Special Tools and Equipment**

No special tools or equipment required by the operator for maintenance of the generator sets.

**3-2. Basic Issue Items**

Tools, equipment, and repair parts issued with or authorized for the generator sets are listed in the basic issue items list Appendix C.

## Section II. LUBRICATION INSTRUCTIONS

**3-3. General Lubrication Information**

Lubrication of the various diesel engine generator sets, cargo trucks, and trailers are covered in the following lubrication orders:

- L.O. S-6115-229-20 \_\_\_\_\_ Model 4070 diesel
- L.O. S-6115-247-15 \_\_\_\_\_ Model 54400 diesel
- L.O. 6-6115-425-12 \_\_\_\_\_ Model SF60MD (CIED)
- L.O. 9-2320-211-10 \_\_\_\_\_ M54A2 cargo truck
- L.O. 9-2330-205-14 \_\_\_\_\_ M200A1 generator trailer

**3-4. Detailed Lubrication Information**

*a. General.* Keep all lubricants in closed containers and store in a clean, dry place away from external heat. Allow no dirt, or other foreign material to mix with the lubricants, keep all lubrication equipment clean and ready to use.

*b. Cleaning.* Keep all external posts not

requiring lubrication clean of lubricants, Before lubricating equipment wipe all lubrication points free of dirt and grease. Clean all lubrication points after lubrication to prevent accumulation of foreign matter.

*c. Points of Lubrication.* Service the lubrication points as illustrated in the appropriate lubrication order.

*d. OES Oil,* The crankcase oil level of the diesel engine draining the generator sets, and the M54A2 truck (PU-408/M, PU-700/M) must be checked frequently as oil consumption may increase. Also the oil may require changing more frequently than usual because of fuel dilution and sludge formation increase under cold weather operation conditions.

## Section III. PREVENTIVE MAINTENANCE CHECKS AND SERVICES

**3-5. General**

To insure that the DE generator set is ready for operation at all times, it must be inspected systematically so that defects may be discovered and corrected before they result in serious damage or failure. The necessary preventive maintenance checks and services to be performed are listed and described in paragraph 3-6 and appropriate technical manuals. The item numbers indicate sequence of minimum inspection requirements. Defects discovered during operation of the unit will be noted for future correction to be made as soon as operation has ceased. Stop operation immediately if a deficiency is noted during operation which would damage the equipment if operation were continued. All deficiencies and short comings

will be recorded together with the corrective action taken on DA Form 2404 (Equipment Inspection and Maintenance Worksheet ) at the earliest possible opportunity.

**3-6. Preventive Maintenance Checks and Services**

For daily preventive maintenance checks and services for the 45KW generator sets refer to TM 5-6115-239-10, or TM 5-6115-247-15 for the 60KW sets refer to TM 5-6115-425-12, for the M200A1 trailer refer to TM 9-2330-205-14, and for daily PMS on the M54 truck refer to TM 9-2320-211-40. Table 3-1 is a list of the preventive maintenance checks and services for components not covered elsewhere.

Table 3-1. Preventive Maintenance Checks and Services

Item Number	Interval						B—Before Operation	A—After Operation	M—Monthly
	Operator			W	Org.		D—During Operation	W—Weekly	Q—Quarterly
	Daily				M	Q	Item To Be Inspected	Procedure	Reference
	B	D	A						
1	X	X							
						<b>Distribution Box</b>	<p>a. Examine phase meter glasses for chips, cracks, or breakage. During operation, observe that meters register total phase current drain.</p> <p>b. Operate phase control switches, observe whether mechanical action of each switch is smooth and free of binding. Report defective switches to direct support maintenance.</p> <p>c. Check phase indicator lamps by operating phase control switches. Lamp should glow when associated phase control switch is on.</p> <p>d. Check all cables and connectors for cracks, breaks, or other damage. Cable assembly caps must be securely fastened to cable ends when cables are not in use. If cables are connected, check tightness of all connectors.</p>	Fig. 1-9	
2	X								
						<b>Portable Distribution Box</b>	<p>a. Operate control switches. Observe that mechanical action is smooth and free of binding.</p> <p>b. Check indicator lamps by operating control switches. Indicator lamps should glow when associated control switch is ON.</p>	Fig. 5-4.	
3									
						<b>Synchronizer Assy</b>	<p>a. Operate safety circuit breaker, synchronizing switch, and synchronizing bypass switch and observe that mechanical action is smooth and free of binding.</p> <p>b. Check that indicator lamp of safety circuit breaker light glows when power is applied through load cable interconnecting receptacle.</p> <p>c. Check all inter connecting cables and connectors for cracks, and breaks. Replace defective cables.</p>	Fig. 5-4.  Fig. 4-1, 4-2.  Fig. 4-3.	

## Section IV. TROUBLESHOOTING

### 3-7. Troubleshooting

a. For troubleshooting on the diesel engine generator sets refer to TM 5-6115-239-10 or TM 5-6115-247-15 (45KW), or to TM 5-6115-425-12 (60KW). For troubleshooting on the M54A2 truck

refer to TM 9-2320-211 -1'0, and for the trailer to TM 9-2330-205-14.

b. Operator troubleshooting of the distribution boxes, portable distribution boxes, synchronizer assembly (or switchbox) is limited to inspecting for damaged cables and connectors, and proper grounding of system.

## Section V. MAINTENANCE OF GENERATOR SETS

### 3-8. General

The operator of the generator sets is responsible for performance of daily preventive maintenance checks and services on all items of the generator sets. Detailed operator maintenance procedures pertaining to the diesel engine generator units are contained in TM 5-6115-239-10 (model 4070) or TM 5-6115-247-15 (model 54400) for the 45KW units, and in TM 5-6115-425-12 for the military design 60KW units. Operator maintenance for the generator trailer (M200A1 ) is outlined in TM 9-2330-205-14; and for the M54A2 cargo truck, in TM 9-2320-211-10.

### 3-9. Operator's Maintenance

Operator's maintenance of the distribution box, portable distribution boxes, synchronizer assembly or switchbox, accessory boxes, fuel cans, mounting brackets, cables, and associated hardware items consists of the following:

- a. Cleaning the equipment.
- b. Inspecting for missing and damaged items.
- c. Inspecting for loose brackets, braces, and hardware items.
- d. Inspecting power cables, receptacle-connectors for damage and overheating; ground rods and clamps for good connections.



## CHAPTER 4

ORGANIZATIONAL MAINTENANCE INSTRUCTIONS

---

## Section 1. SERVICE UPON RECEIPT OF MATERIEL

**4-1. Inspecting and Servicing Equipment**

No additional instructions required at organizational maintenance level (para 2-1).

## Section II. REPAIR PARTS, SPECIAL TOOLS AND EQUIPMENT

**4-2. Tools and Equipment**

Tools, equipment, and repair parts issued with or authorized for the generator sets are listed in the basic issue items list, Appendix C of this manual.

**4-3. Special Tools and Equipment**

There are no special tools or test equipment required for organizational maintenance; however, the general mechanics tool kit (FSN 5180-754-

0641) and an AN/URM-105 multimeter (TM 11-6625-203-12) for testing power cables and switching is required.

**4-4. Maintenance Repair Parts**

Repair parts and equipment are listed and illustrated in the repair parts and special tools lists covering organizational maintenance for this equipment in TM 5-6115-376-23P.

## Section III. PREVENTIVE MAINTENANCE CHECKS AND SERVICES

**4-5. General**

For quarterly preventive maintenance checks and services for the 45KW generator sets refer to TM 5-6115-239-10 (Model 4070) or TM 5-6115-247-15 (Model 54400). For the 60KW generator sets refer to TM 5-6115-425-12. For the M200A1 trailer, refer to TM 9-2330-205-14; and for the M54A2 cargo truck refer to TM 9-2330-211-10.

**4-6. Preventive Maintenance Checks and Services**

Table 4-1 is a list of the quarterly preventive maintenance checks and services for components not covered elsewhere. In addition to the quarterly maintenance procedures; organizational maintenance must also perform the daily steps outlined in table 3-1.

Table 4-1. Preventive Maintenance Checks and Services

Item Number	Interval						B—Before Operation	A—After Operation	M—Monthly
	Operator			Org.			D—During Operation	W—Weekly	Q—Quarterly
	Daily			W	M	Q	Item To Be Inspected	Procedure	Reference
	B	D	A						
1						X	Distribution Box	<p>a. Inspect covers, retainer screws and side panels for warpage, bent hinges, or damaged threads on cover retainer thumbscrews.</p> <p>b. Inspect phase receptacle connection caps for bent or broken contact pins.</p> <p>c. Inspect receptacle-connector caps for defective threads and for frayed cable insulation around caps.</p>	
2						X	Portable Distribution Box	<p>a. Inspect cover and side panels for warpage, hinges for binding and bent or broken latches.</p> <p>b. Inspect support legs for ease of operation and holding ability.</p> <p>c. Inspect power input receptacle-connector for bent or broken contact pins and receptacle dust cap for damaged threads and secure mounting to cable and case. Inspect output power duplex receptacle assemblies for loose or worn surfaces.</p>	
3						X	Synchronizer Assembly	<p>a. Inspect handles, dust cap clamps and synchronizing switches, door hinge and latch, for secure mounting hinges not binding and latch holds door securely closed.</p> <p>b. Inspect mounting assembly for broken weld, bent angle irons. Inspect holddown assembly for bent arms, stripped turnbuckle threads and canvas straps for mildew or rotting.</p> <p>c. Inspect receptacle contact pins for bends or breakage, damaged threads on dust caps, and secure mounting of chains.</p>	
4						X	Stationary Accessory Box and Contents	Inspect door for warpage, hinge for binding; and for broken or bent latch.	

5					X	Portable Accessory Box and Contents	Inspect cover for warpage and secure fit, hinge for binding and secure mounting bent or broken latches, and secure handle mounting.
6					X	Miscellaneous Items	<p>a. Inspect fuel cans for loose handles, and gas cap and gaskets for fit and sealing; inspect sledge hammer for split handle and chipped head, and ground rods for straightness, corrosion, and corroded connections.</p> <p>b. Inspect extinguishers for broken nozzles, bent handles, cracked hose, and date of inspection tag.</p> <p>c. Examine cable reels for broken welds and corrosion. Inspect holddown rods for warpage, bent handles, and stripped threads. Repair or replace defective rods and reels.</p> <p>d. Lubricate all door and cover hinges, latches, and metal-to-metal moving parts.</p> <p>e. Inspect condition of lifting sling and towing cables for brakes, welds, loose shackles, frayed cables, excessive eye-let wear, hooks and O-rings for damage and secure attachment to cable and damaged turn-buckle threads.</p>

Section IV. TROUBLESHOOTING

4-7. General

For organizational maintenance troubleshooting on the diesel engine generator sets, refer to TM 5-6115-239-10 or TM 5-6115-247-15 (45KW), or to TM 5-6115-425-12 (60KW), For troubleshooting on the M200A1 trailer, refer to TM

9-2330-205-14, and for troubleshooting on the M54A2 truck refer to TM 9-2320-211-10.

4-8. Component Troubleshooting

Refer to table 4-2 for organizational troubleshooting of the distribution boxes and switchboxes.

Table 4-2. Troubleshooting (Organizational)

Malfunction	Probable cause	Corrective action
	<i>Distribution Box</i>	
1. Ammeters don't register or are erratic	Poor connections, or power not on	Check that all connections are secure and power is on
2. Circuit breaker switches inoperative	Faulty contacts or defective switch	Replace a defective switch, clean contacts
3. Connector-receptacle cracked, bent or corroded	Burred, or corroded	Replace defective connector-receptacles
4. Indicator lights won't glare	a. Power off b. Lamp out c. Bad socket	a. Apply power b. Replace lamp c. Replace socket
5. Defective wiring	Loose, or burned wiring	Replace individual wires
	<i>Portable Distribution Boxes</i>	
1. Lamps do not glow	Power off, or load off or lamp burned out	Check input power connection and load connections. Replace a defective bulb.
2. Circuit breaker switches inoperative	Faulty connections or defective switch	Replace a defective switch, check connections
3. Duplex sockets cracked or holes enlarged	Excessive wear	Replace socket
4. Power inlet Connections faulty	Bent or broken pins, cracked connector	Replace connector
	<i>Synchronizer Assembly (PU-407/M)</i>	
1. Synchronizer assembly fails to supply power	a. Power cable input receptacle loose or defective b. Power cable output receptacle loose or defective c. Relay switch defective d. Toggle switch defective e. Automatic switch defective  f. Synchronizer defective g. Wiring defective	a. Tighten or replace b. Tighten or replace c. Replace relay switch d. Replace toggle switch e. Adjust, repair, or replace automatic switch f. Replace synchronizer g. Replace wiring
2. Pilot lamp fails to operate	a. Defective wiring b. Lamp defective c. Loose terminal	a. Repair or replace wiring b. Replace lamp c. Tighten terminal
	<i>Switch Box (PU-699/M)</i>	
1. Circuit breaker switches inoperative	Faulty connection or defective switch	Check connections; replace adequate switch
2. Input and/or output receptacles loose or defective	Input and/or output receptacles loose or defective	Tighten or replace receptacle



## Section V. MAINTENANCE OF GENERATOR SETS

### 4-9. General

Detailed organizational maintenance procedures pertaining to the diesel engine generator sets may be found in TM 5-6115-239-10, TM 5-6115-247-15 (45KW) or TM 5-6115-425-12 (60KW) ; for the M200A1 trailer refer to TM 9-2330-205-14, and for the M54A2 truck refer to TM 9-2320-211-10.

### 4-10. Generator Set Batteries (All Units)

#### WARNING

**Handle batteries carefully. Electrolyte contains sulphuric acid and can cause severe burns. If solution comes in contact with body or clothing, flush affected area with water immediately.**

#### NOTE

Removal and replacement of M54A2 cargo truck batteries is covered in TM 9-2320-211-10.

*a. Removal.* Refer to figure 4-1 and remove batteries from generator unit.

*b. Installation.* Install batteries in reverse order of removal. Be sure to observe proper polarity when connecting battery terminals and jumper cable.

### 4-11. Fuel Can Brackets (All Units)

The fuel can brackets on the generator trailer (PU-407/M, PU-699/M) are located on the front roadside fender assembly (fig. 1-2 (1), are removed and installed as described in *a* and *b* below. The fuel can brackets on the cargo truck (PU-408/M, PU-700/M) are located on the curbside of the skid platform, between the reels and generator set and are removed and installed in a similar manner after the skid platform has been removed from the cargo truck,

*a. Removal.* Unbuckle straps and remove fuel cans (2) from bracket. Loosen and remove nuts, washers and lockwashers (underneath fender step) that secure fuel can bracket. Lift off bracket and remove mounting bolts. Straighten bracket if bent or replace a defective bracket.

*b. Installation.* Place bracket *over* mounting holes in fender step and insert bolts. Replace mounting hardware and tighten securely. Install fuel cans and tighten straps.

### 4-12. Power Cables (45KW) (PU-407/M, PW408/M)

*a. Removal of Distribution Box Cable B or E.*

(1) Remove screws and remove distribution box back cover plate (fig. 4-2).

(2) Loosen cap at cable entrance fitting at bottom of distribution box; slide cap back on power cable.

(3) Loosen watertight bushing inside cable entrance fitting and slide it back on distribution box.

(4) Loosen locking nuts and remove the four cable leads (not shown) from distribution box bus bar terminal (fig. 4-2).

(5) Withdraw cable and slide off bushing and cap.

#### *b. Installation of Distribution Box Cable B or E.*

(1) Slide cable entrance fitting cap onto power cable so threaded end is toward prepared cable leads. Slide watertight bushing onto power cable so tapered end of bushing is toward prepared leads.

(2) Insert cable through cable entrance fitting and connect prepared leads to bus bar terminals as follows:

Black (phase A) _____	Terminal No. 1
Red (phase B) _____	Terminal No. 2
Green (phase C) _____	Terminal No. 3
White (neutral) _____	Terminal No. 4

(3) Press watertight bushing into cable entrance fitting and tap firmly in place.

(4) Replace and tighten cap on cable entrance fitting.

(5) Replace distribution box back cover plate and tighten screws.

#### *c. Removal of Generator Cable A or D.*

(1) Raise right-hand diesel engine access **door** closest to generator set control panel and secure in open position.

(2) Follow procedures. in a(2) through (5) above to remove cable from generator set output terminals.

#### *d. Installation of Generator Cable A or D.*

(1) Install power cable as described in b(1) through (4) above; connect leads to generator output terminals as follows:

Black (phase A) _____	Terminal L1
Red (phase B) _____	Terminal L2
Green (phase C) _____	Terminal L3
White (neutral) _____	Terminal LO

(2) Replace a defective cable; lower and secure diesel engine access door.

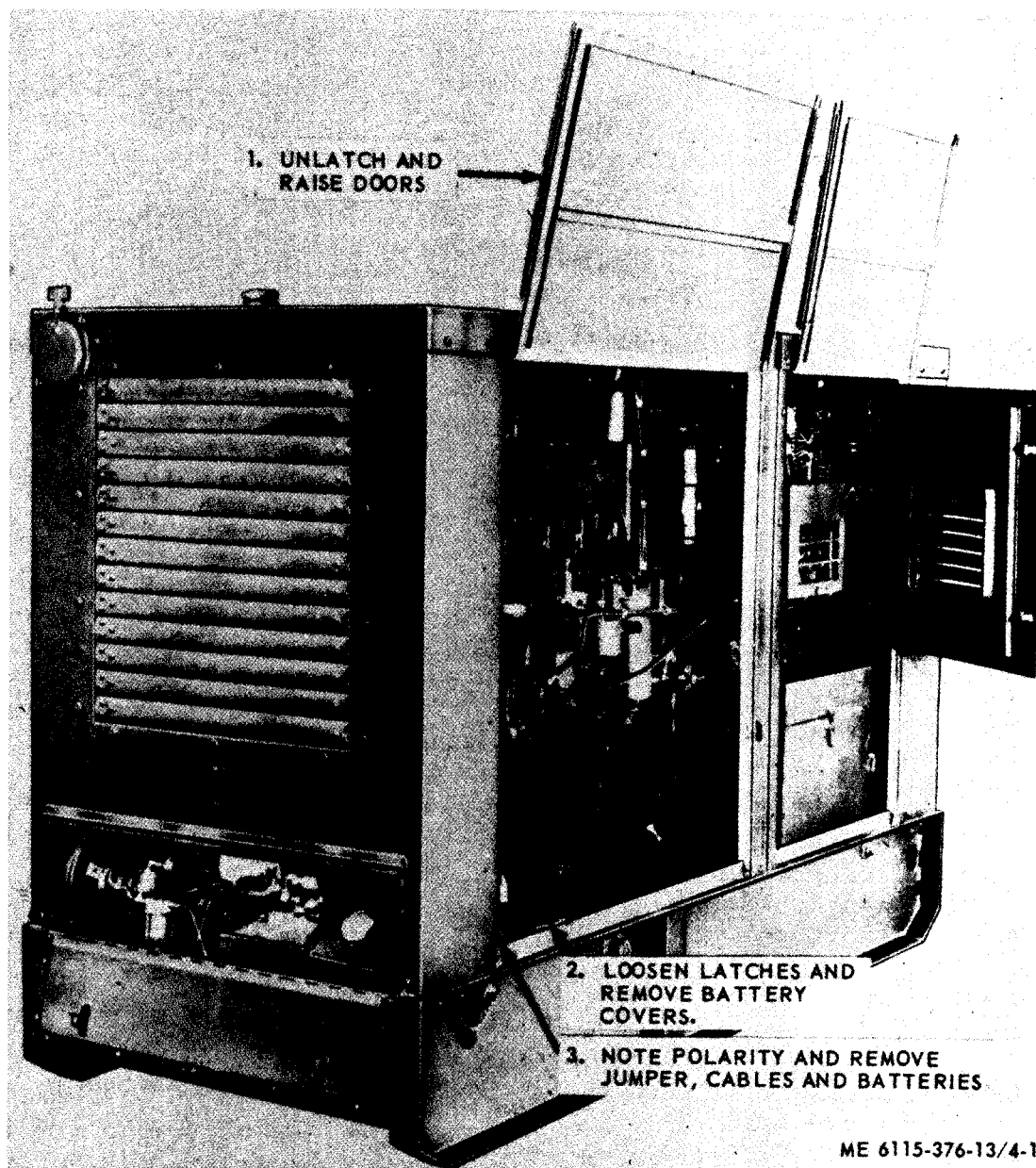

ME 6115-376-13/4-1

Figure 4-1. Removal and installation of generator set batteries.

**4-13. Power Cables, 60KW (PU-699/M, PU-700/M)**

The 60KW power cables used on the generator trailer and cargo truck are removed and installed in a similar manner as the 45KW cables (para 4-12). The trailer cables are 11 feet long, the truck cables are 19 feet 6 inches long. Replace a defective power cable.

**4-14. Testing 45KW and 60KW Power Cables**

a. *General* Use the AN/URM-105 arranged as

an ohmmeter, to test power cables for shorts, open circuits, and transpositions,

b. *Short Circuit Test.* Connect ohmmeter leads to power cable connector pins as shown below. Be sure prepared leads do not touch one another during test.

Connect red Lead to pin number	Connect black lead to pin number	Meter Indications (ohms)
1.....	2.....	Infinity
1.....	3.....	Infinity
2.....	3.....	Infinity
2.....	4.....	Infinity
3.....	4.....	Infinity

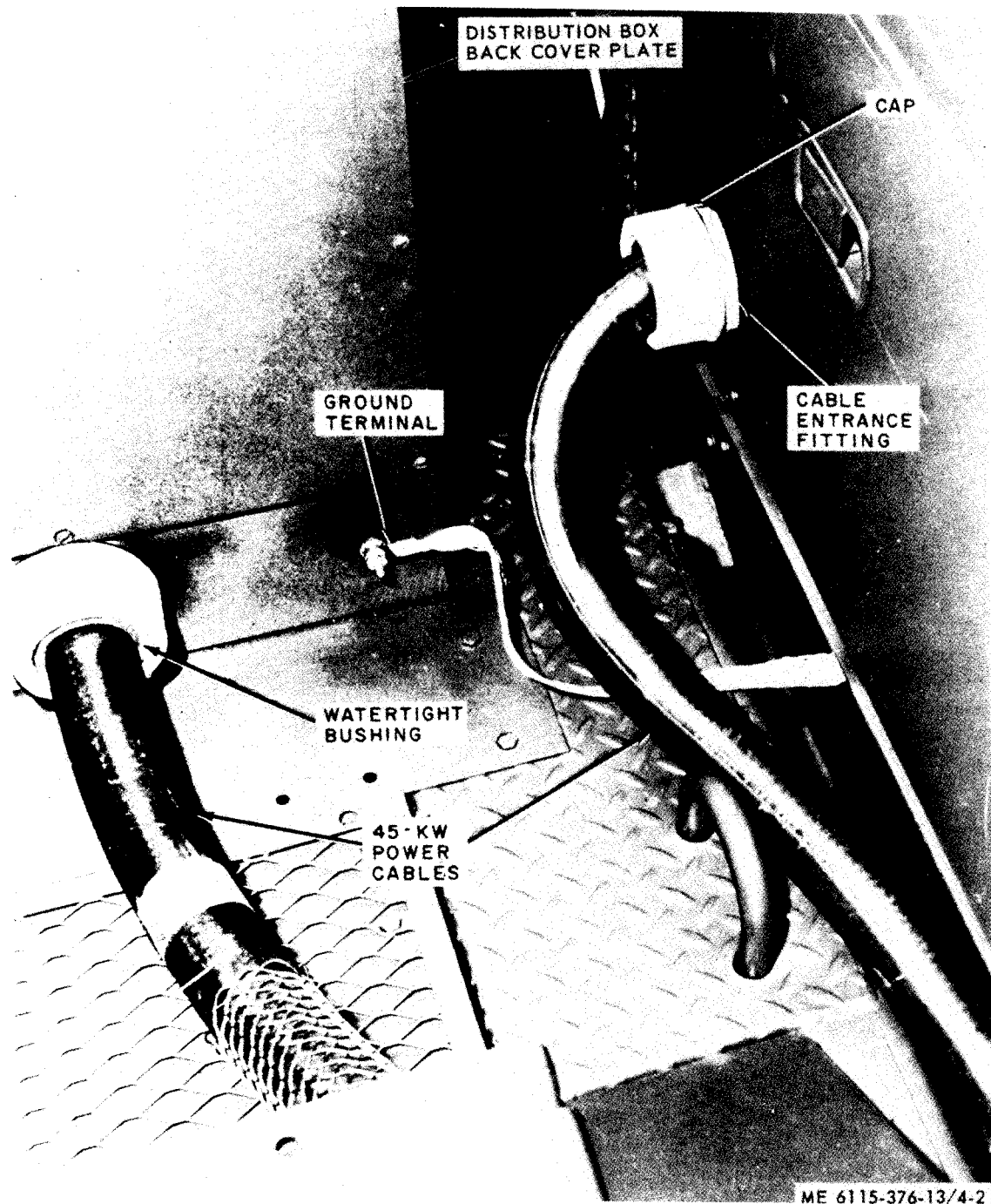

Figure 4-2. Removal and installation of 45KW power cables (PU-407/M; (PU-408/M similar).

*c. Open Circuit and Transportation Test.*

(1) Connect ohmmeter leads between power cable connector pins and prepared leads as shown below.

Connect red Lead to pin number	Connect black lead to cable lead	Meter Indications (ohms)
1	Black	0
2	Red	0
3	Green	0
4	White	0

(2) An open circuit meter indication (infinity) may indicate an open conductor or cable transposition. Identify condition by following procedures in (a) and (b) below.

(a) Leave red ohmmeter lead connected to cable connector pin and touch black ohmmeter lead to the three remaining power cable leads, in turn.

(b) A transposition between cable con-

ductor and connector pins will be indicated by a meter indication of 0 ohms.

**4-15. Testing Synchronizer Assembly (PU-407/M)**

Use the AN/URM-105, arranged as an ohmmeter,

to test circuits of the synchronizer assembly. Perform the resistance measurements given in table 4-3, with all power removed from equipment. Test safety circuit breaker light DS1 by substitution (fig. 2-9).

Table 4-3. Test Connections

From		Connections		To		Resistance (ohms)	Remarks
Connector	Terminal	Connector	Terminal	Connector	Terminal		
Power input	1	Power output	1		1	Infinity	Ground terminal
	2		2		Infinity		
	3		3		Infinity		
	4		4		0		
Parallel cable power unit	A	Parallel cable interconnecting switch box	A		A	Infinity	Terminals A and D are shorted
	B		B		Infinity		
	C		C		0	Terminals A and D are shorted	
	D		D		Infinity		
Power output	2	Load cable interconnecting switch	2		2	0	With safety ckt bkr lamp on
	3		3		0		
	1		1		0		
Load cable interconnecting switch-box	2		2		2	Infinity	

**4-16. Testing Switchbox (PU-699/M)**

With the AN/URM-105 arranged as an ohmmeter, place test probe on each side of switch (S1 through S4) and with power off and switch S1 in on position, meter should show continuity. Do this on all three circuits of each switch. If one circuit does not show continuity, the switch is defective and must be replaced.

**4-17. Ancillary Items**

If the brackets, braces, mounting bases and accessory boxes are bent or missing hardware, remove and straighten. If unable to correct, replace the defective item. Replace missing hardware.

**4-18. Distribution Boxes**

*a. Inspection.* Inspect condition of circuit breakers, panel assembly bus bars, current transformers, ammeters and wiring. If circuit breakers don't operate smoothly, panel is dented, bus bars corroded, ammeters sticking, transformers burned, or wiring is burned or loose, refer conditions to direct support maintenance.

*b. Connector-Receptacles.* There are nine connector-receptacles on each distribution box, one on each portable distribution box. If visual inspection indicates a cracked or corroded connector-

receptacle or damaged threads, replace it as follows.

(1) Prop open the front cover of distribution panel of the distribution box and remove receptacle cover.

(2) Remove back panel of distribution box. Remove cover and attaching hardware. Tag and disconnect wiring, then remove connector-receptacle (fig. 4-4).

(3) Install replacement connector-receptacle in distribution panel, install mounting hardware, connect wiring, and receptacle cover, install back panel and close front panels. Replace a defective

(4) To replace defective connector-receptacle in portable distribution box (fig. 4-5), lift lid and remove screws holding control panel. Prop up the control panel and remove mounting hardware. Remove connector cover, tag and disconnect wire leads and remove connector-receptacle from portable distribution box.

(5) Install replacement connector-receptacle in portable distribution box, and install mounting hardware and cover. Install wire leads, insert control panel into place inside the portable distribution box, add mounting screws and close lid. Replace a defective receptacle cover.

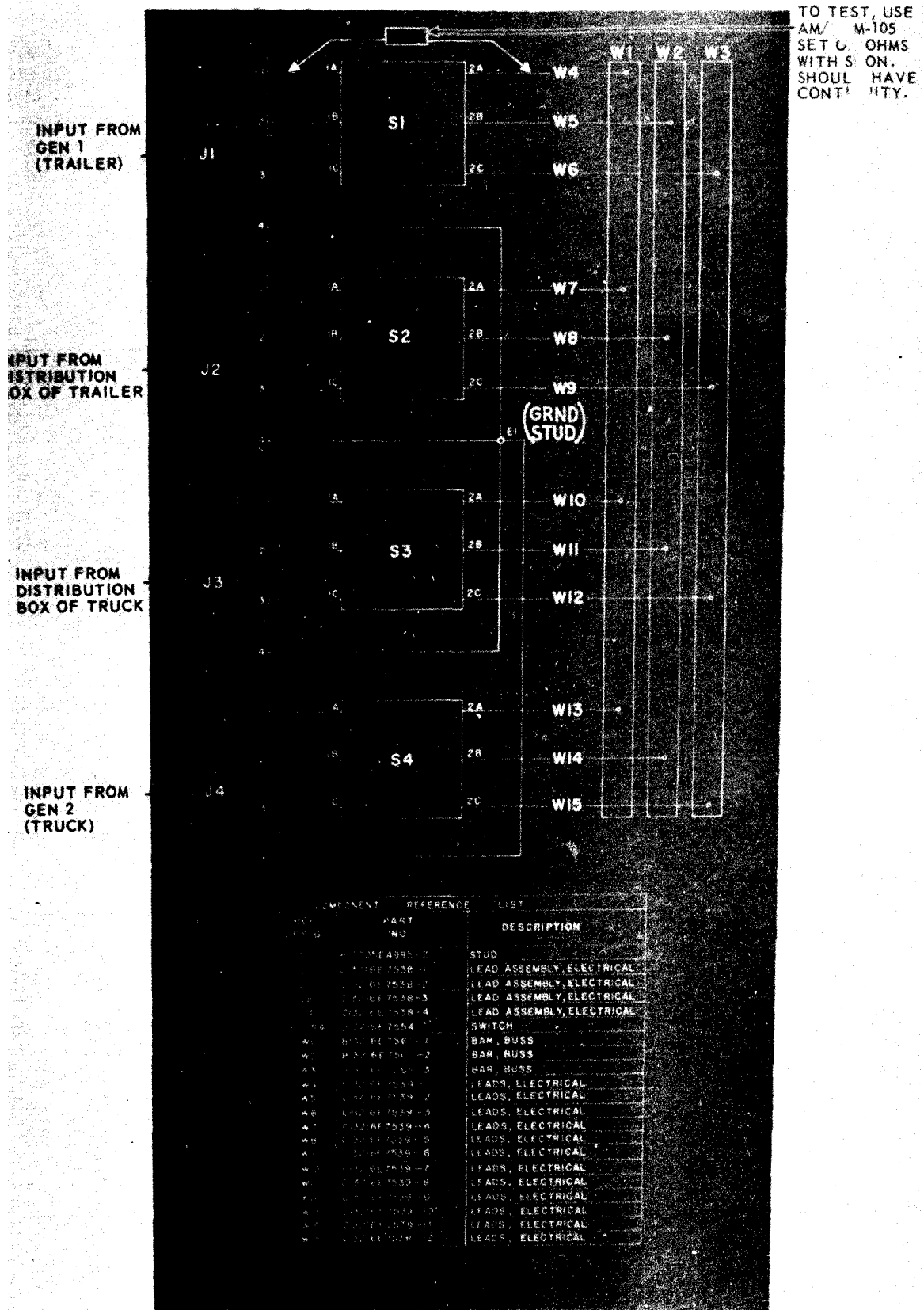

COMPONENT	REFERENCE	LIST
NO.	PART NO.	DESCRIPTION
1	10-1014995-2	STUD
2	10-1014995-3	LEAD ASSEMBLY, ELECTRICAL
3	10-1014995-4	LEAD ASSEMBLY, ELECTRICAL
4	10-1014995-5	LEAD ASSEMBLY, ELECTRICAL
5	10-1014995-6	LEAD ASSEMBLY, ELECTRICAL
6	10-1014995-7	SWITCH
7	10-1014995-8	BAR, BUSS
8	10-1014995-9	BAR, BUSS
9	10-1014995-10	BAR, BUSS
10	10-1014995-11	LEADS, ELECTRICAL
11	10-1014995-12	LEADS, ELECTRICAL
12	10-1014995-13	LEADS, ELECTRICAL
13	10-1014995-14	LEADS, ELECTRICAL
14	10-1014995-15	LEADS, ELECTRICAL
15	10-1014995-16	LEADS, ELECTRICAL
16	10-1014995-17	LEADS, ELECTRICAL
17	10-1014995-18	LEADS, ELECTRICAL
18	10-1014995-19	LEADS, ELECTRICAL
19	10-1014995-20	LEADS, ELECTRICAL
20	10-1014995-21	LEADS, ELECTRICAL
21	10-1014995-22	LEADS, ELECTRICAL

ME 6115-376-13/4-3

Figure 4-3. Testing switchbox of PU-699/M.

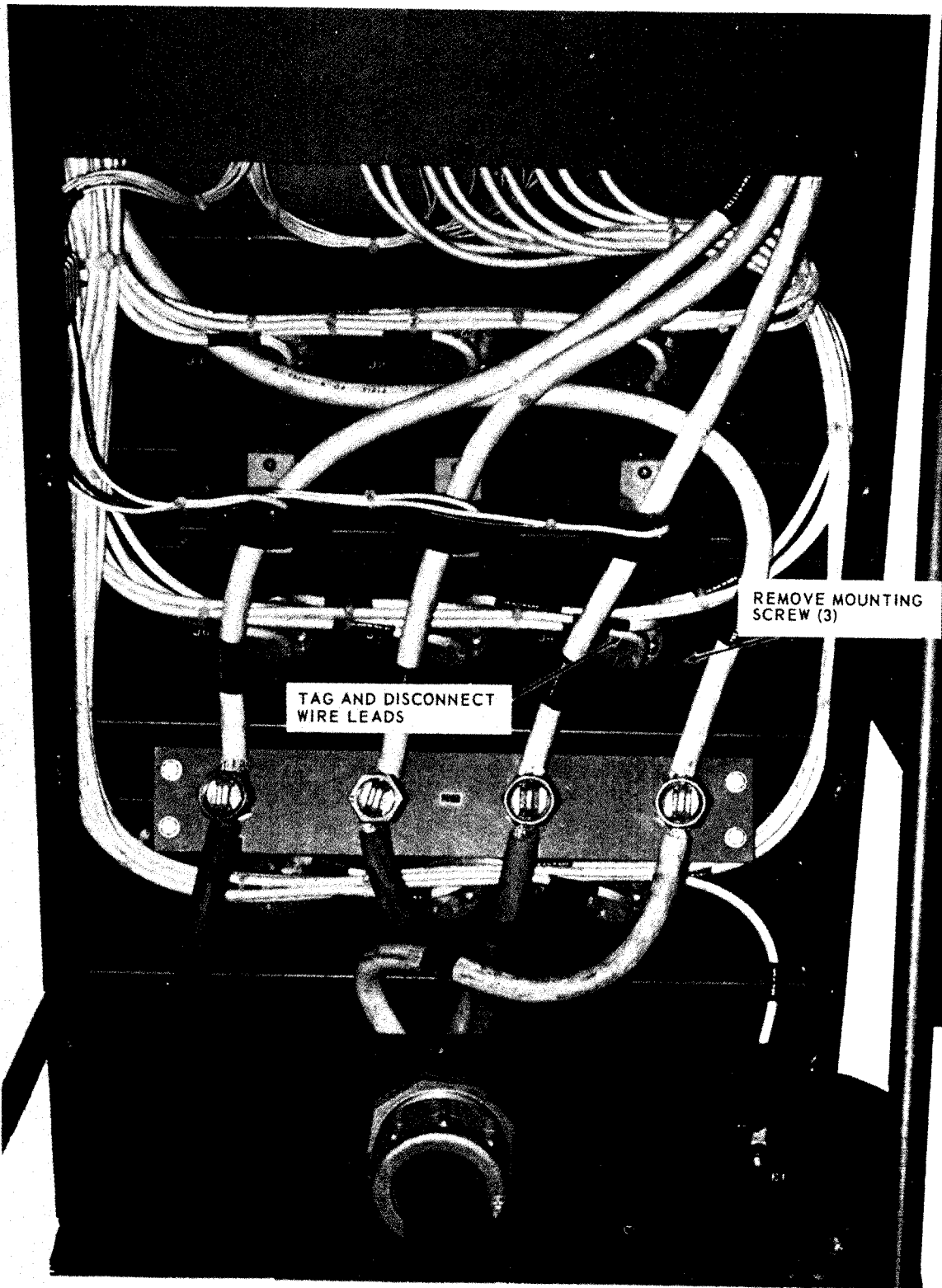

ME 6115-376-13/4-4

Figure 4-4. Removal and installation of connector-receptacle of distribution boxes.

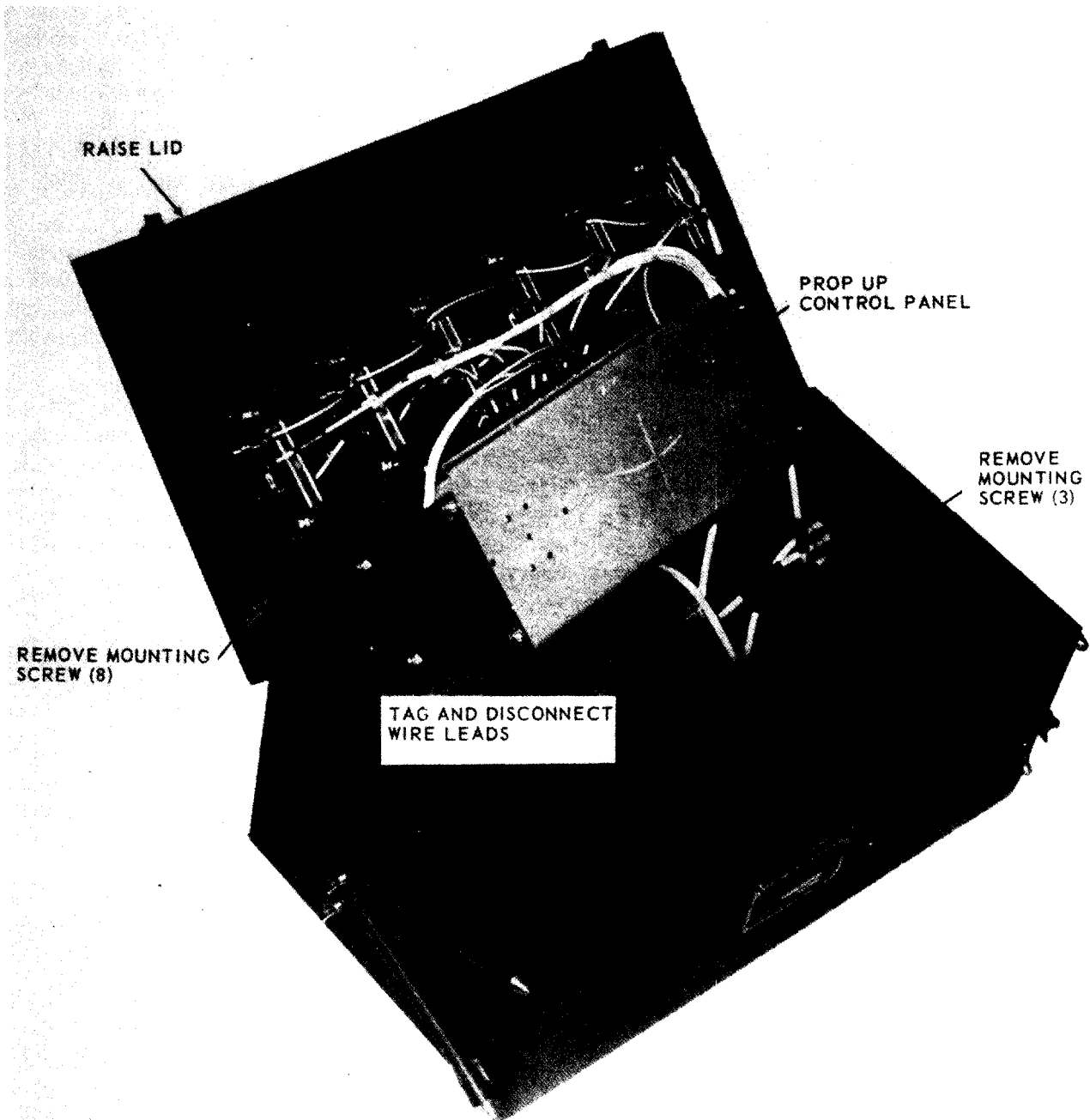

ME 6115-376-13/4-5

Figure 4-5. Removal and installation of connector-receptacle of portable distribution

*c. Indicator Lights.* There are nine lights on the control panel of the distribution box, and six lights on the control panel of the portable distribution box: all are the same light bulb and lens, and are removed and installed as shown in figure 4-6.

#### **4-19. Synchronizer Assembly (PU-407/M)**

*a. Inspection.* Inspect condition of circuit breaker, panels, toggle switches, automatic switch, electronic synchronizer, bus bar and wiring. Activate circuit breaker and if action is not smooth; if "bus bar is corroded, electronic synchronizer inoperative, wiring is burned or bare, report conditions to direct support maintenance,

*b. Indicator Lights, Lens, and Wiring.* Remove and install indicator lens and light bulbs as shown in figure 4-7.

*c. Power Receptacle Cover and Dust Clamps.* Refer to figure 4-8 and remove and install power receptacle cover and dust cap clamp. (Installation is the reverse order of removal).

*d. Power Receptacle-Connector, Parallel Receptacle-Connector, Bus Bar, and Power Leads.*

Refer to figure 4-9(1) and 4-9(2) and remove components as directed. Install power receptacle-connectors, parallel connectors, bus bar and power leads in reverse order of removal.

*e. Toggle Switches.* Refer to figure 4-10 and remove toggle switches as directed. Install replacement toggle switches in reverse order of removal.

#### **4-20. Switchbox (PU-699/M)**

*a. Inspection.* Inspect condition of circuit breaker switches, panels, bus bars, connector-receptacles and covers. If circuit-breaker switches work improperly, or if bus bars are corroded, and wire leads burned or bare, report condition to direct support maintenance.

*b. Connector-Receptacles and Covers.* To replace a connector-receptacle, remove back panel of switchbox, tag and disconnect wire leads and remove mounting hardware and cover as shown in figure 4-11. Replace a defective cover. Install replacement connector-receptacle in reverse order of removal.



UNSCREW LENS COUNTERCLOCKWISE TO EXPOSE BULB. PUSH IN ON BULB, TWIST LEFT SLIGHTLY AND REMOVE BULB. INSTALL NEW BULB (PUSH IN AND TWIST RIGHT SLIGHTLY; SCREW LENS BACK ON SOCKET.

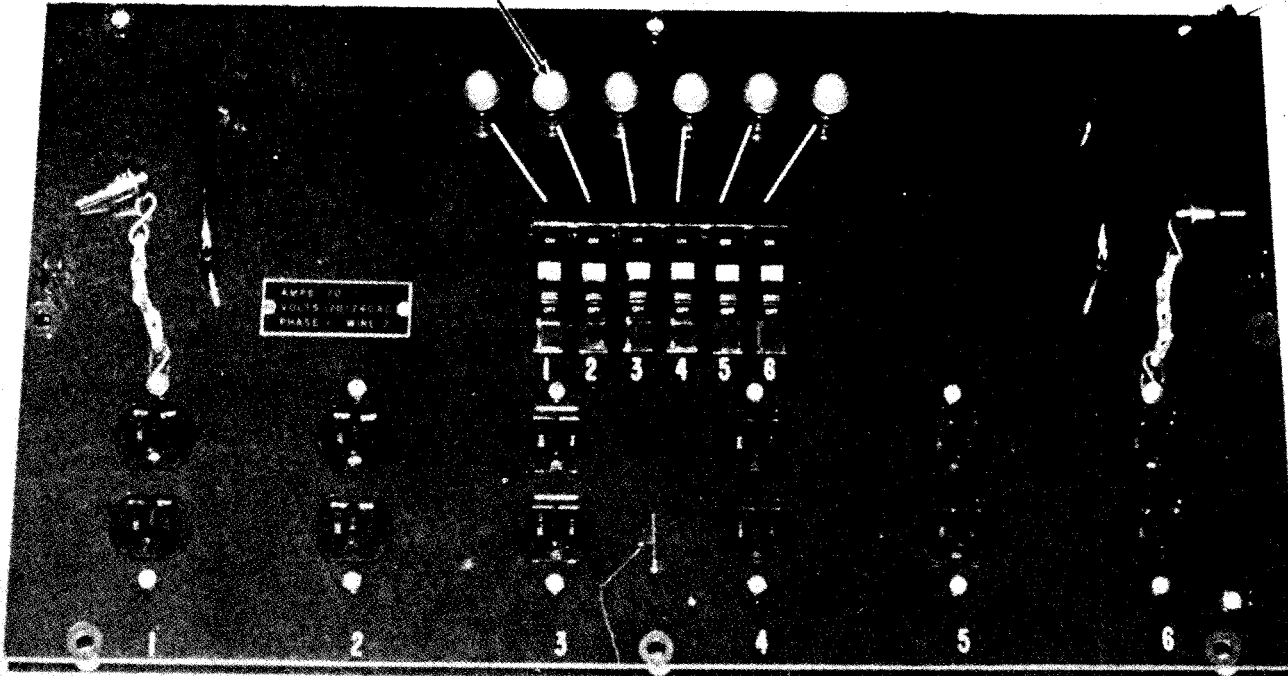

NOTE:  
LENS AND LIGHTS OF  
DISTRIBUTION BOX  
ARE REMOVED AND  
INSTALLED IN A SIMILAR  
MANNER.

ME 6115-376-13/4-6

Figure 4-6. Distribution box indicator lights removal and installation.

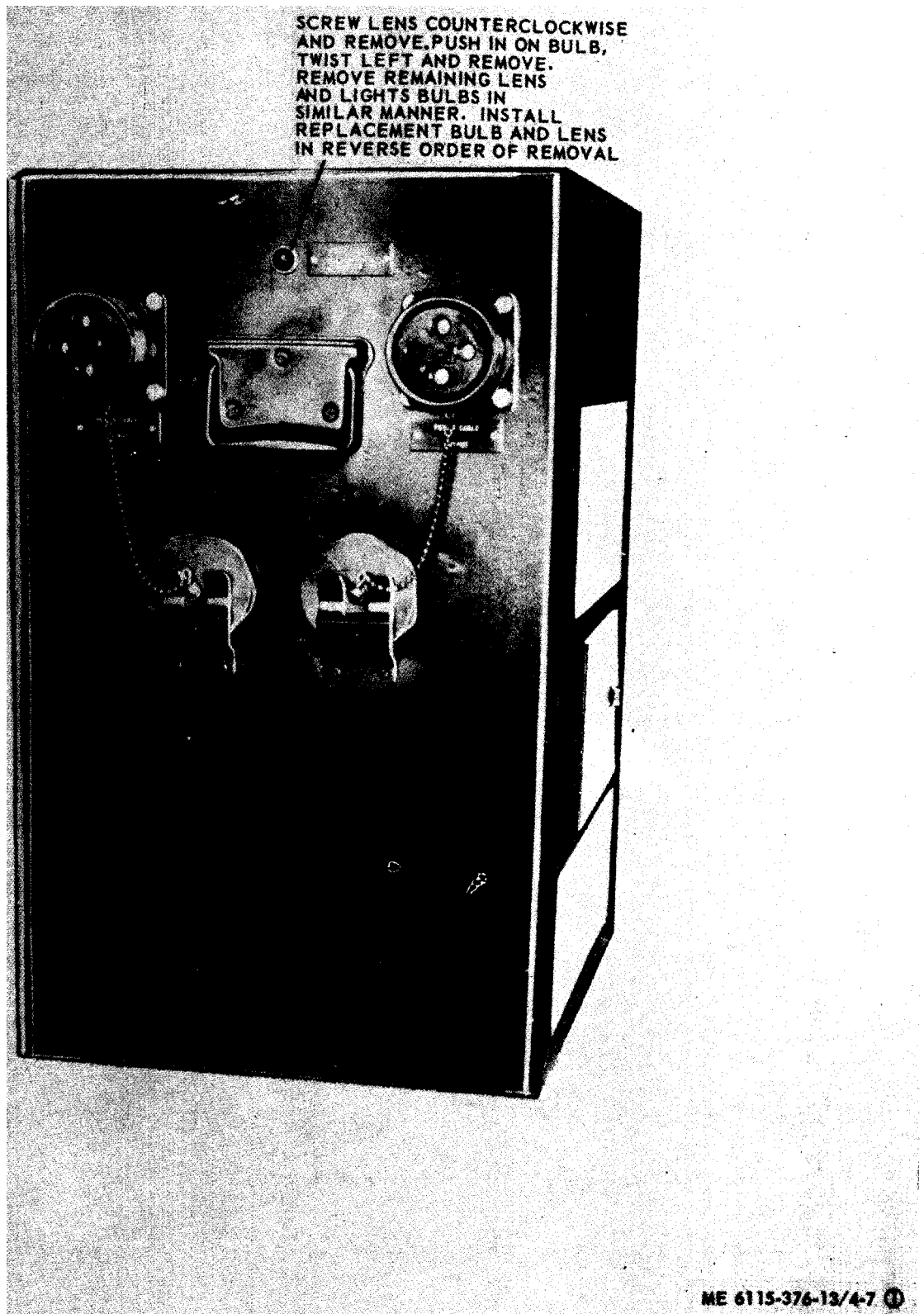

Figure 4-7. Synchronizer assembly indicator lights, lens and wiring, removal and installation. (Sheet 1 of 2)

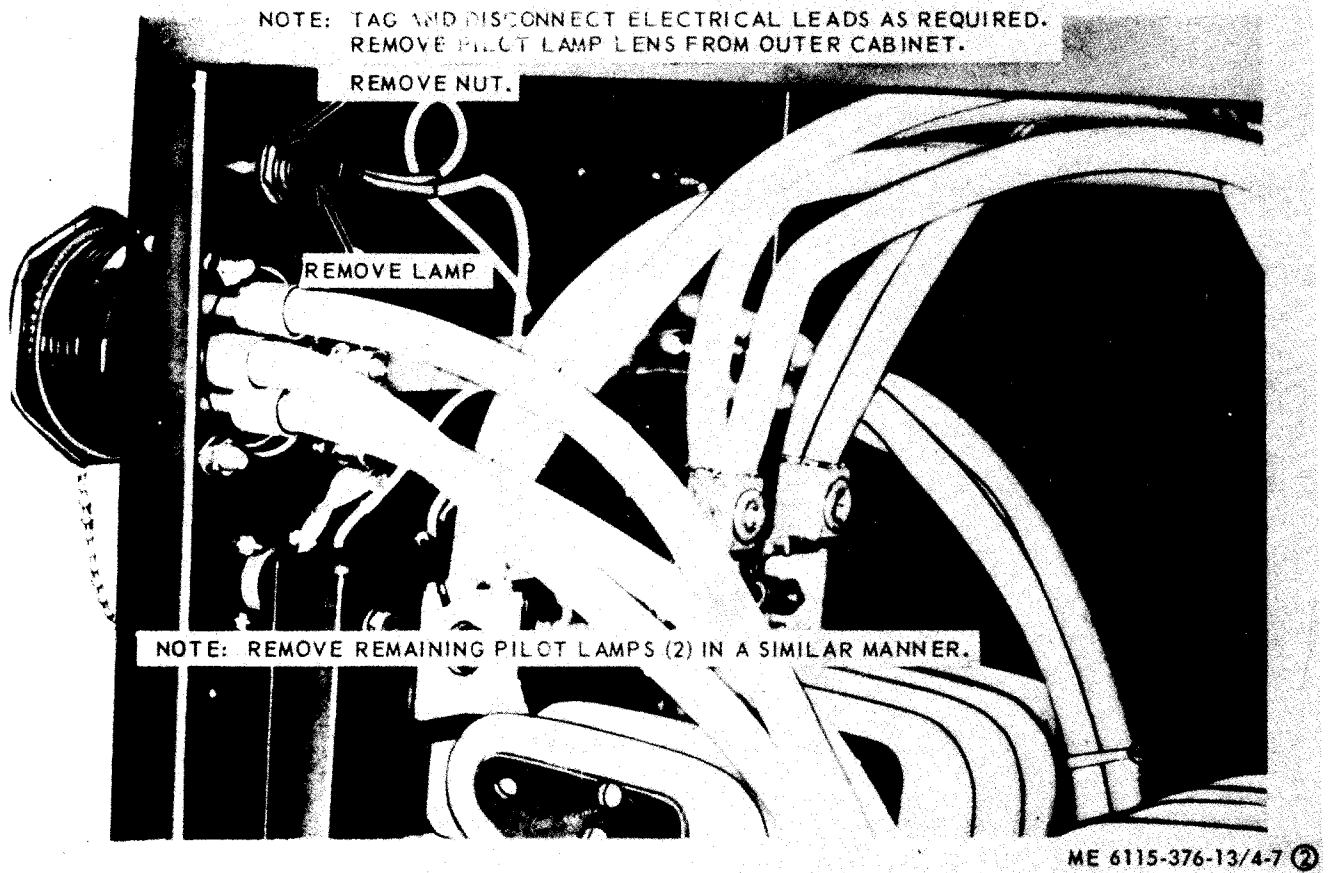

Figure 4-7. Synchronizer assembly indicator lights, lens and wiring, removal and installation. (Sheet 2 of 2).

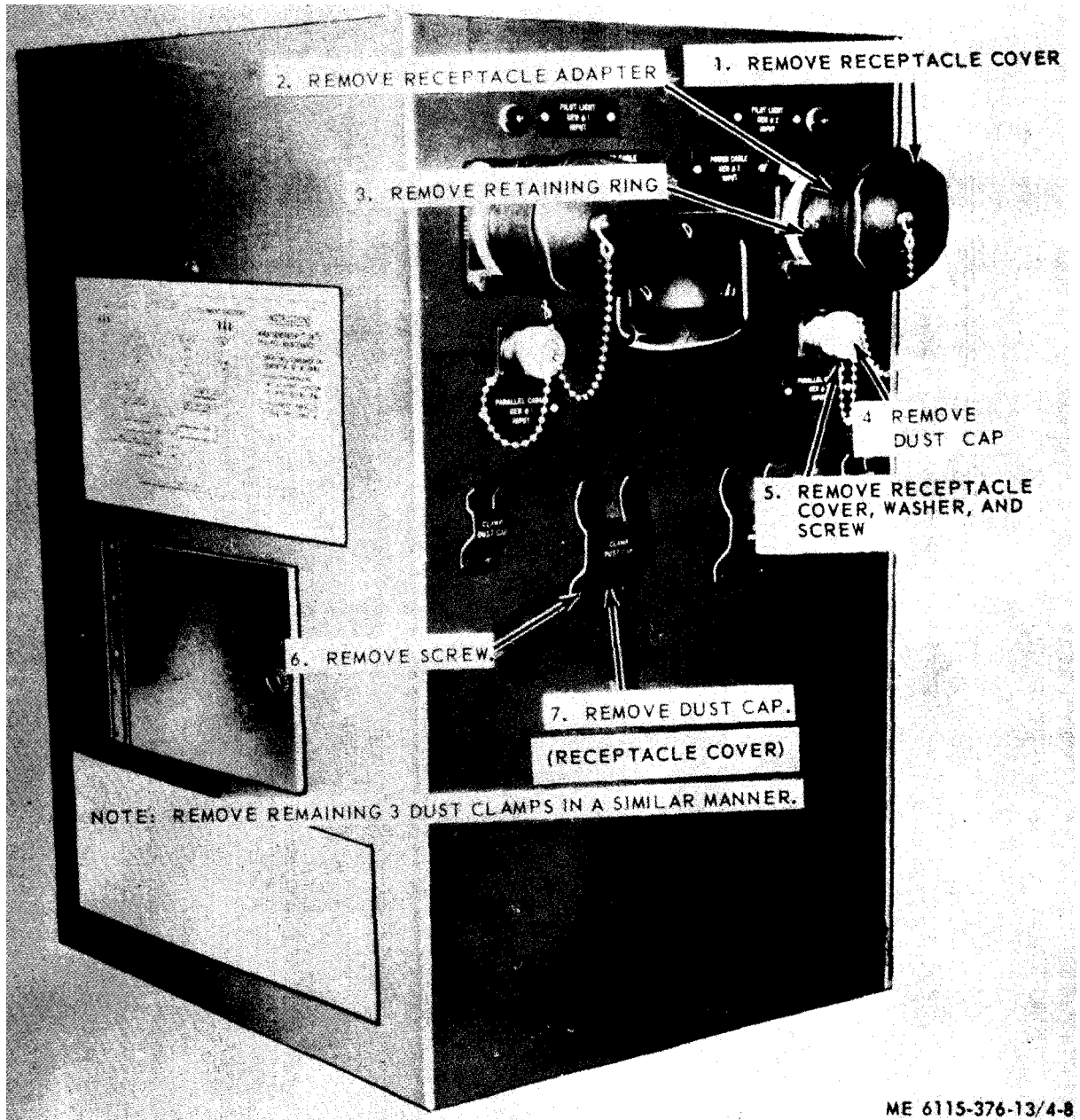

Figure 4-8. Synchronizer assembly power receptacle cover and dust cap clamp removal and installation.

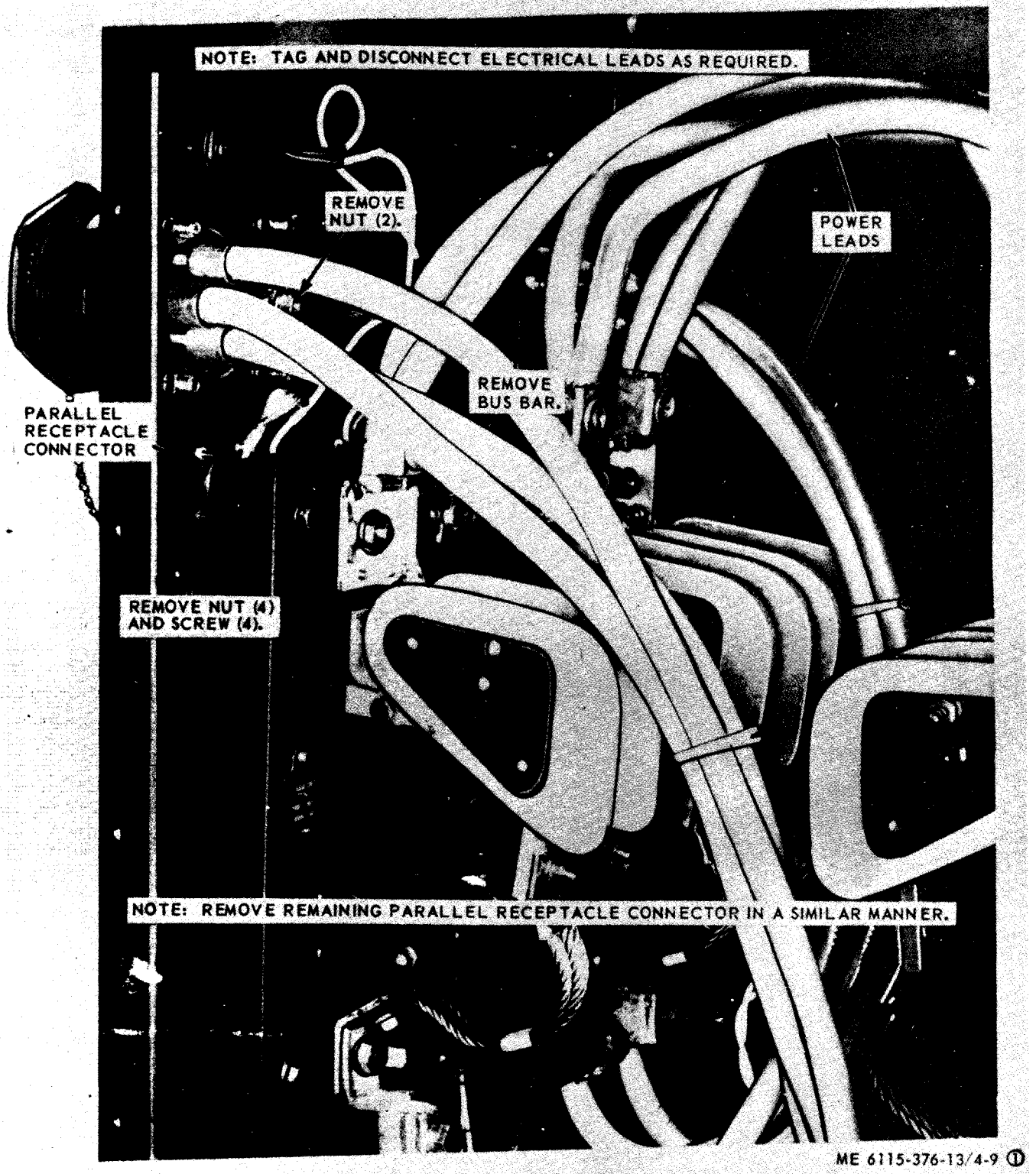

Figure 4-9. Synchronizer assembly power receptacle-connector, parallel receptacle-connector, bus bar and power leads, removal and installation (Sheet 1 of 2).

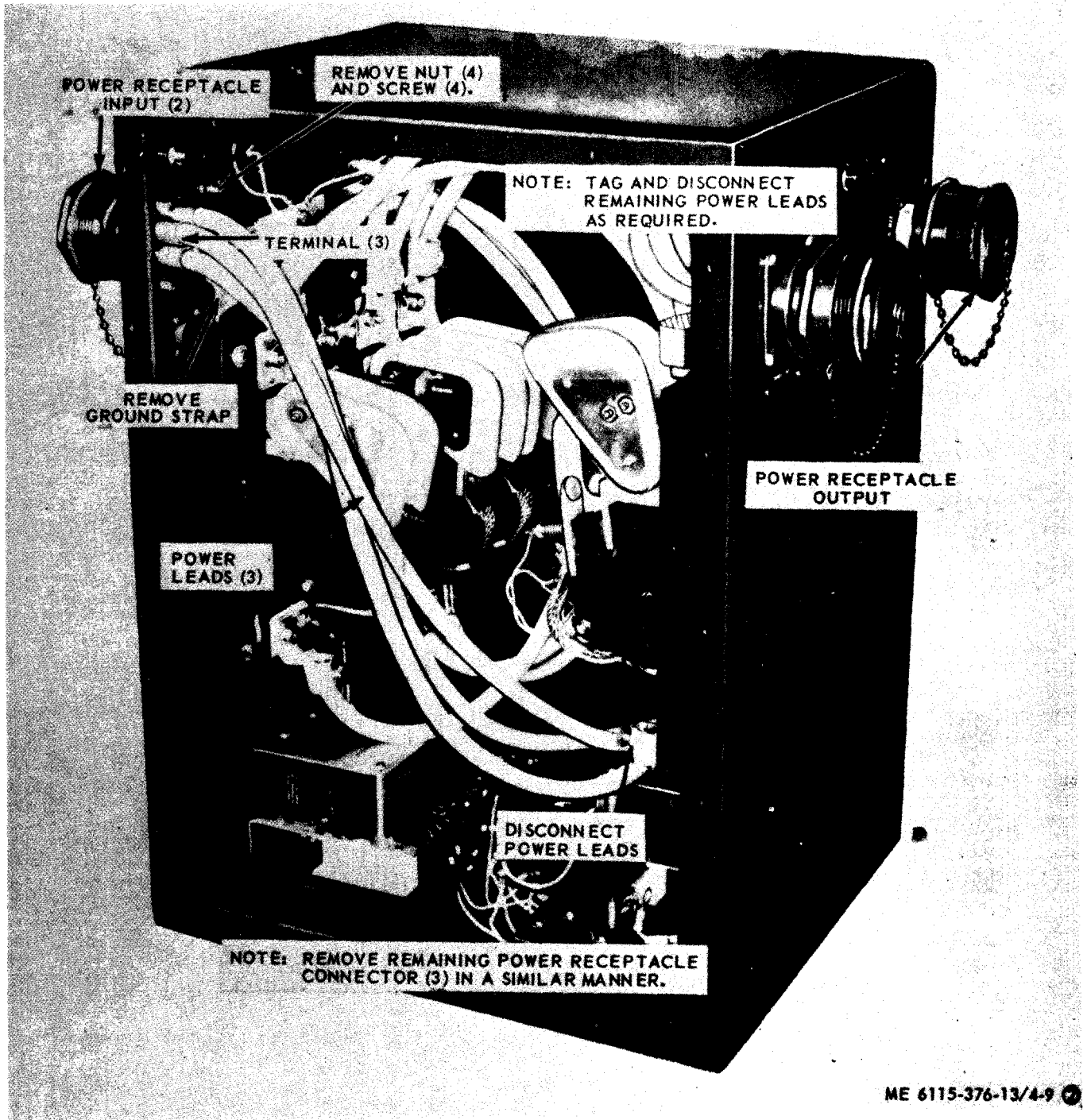
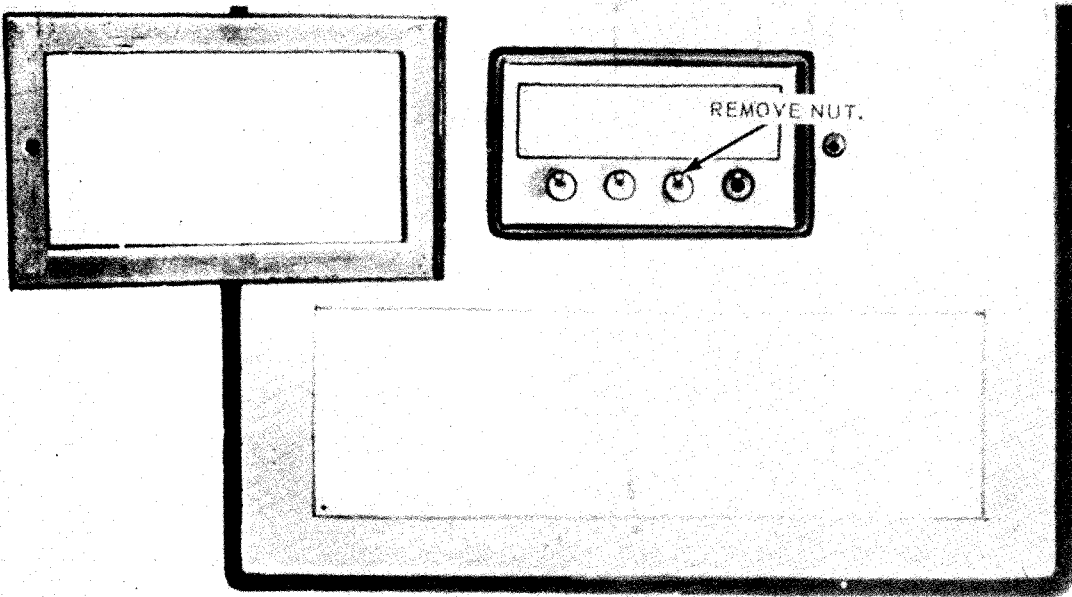
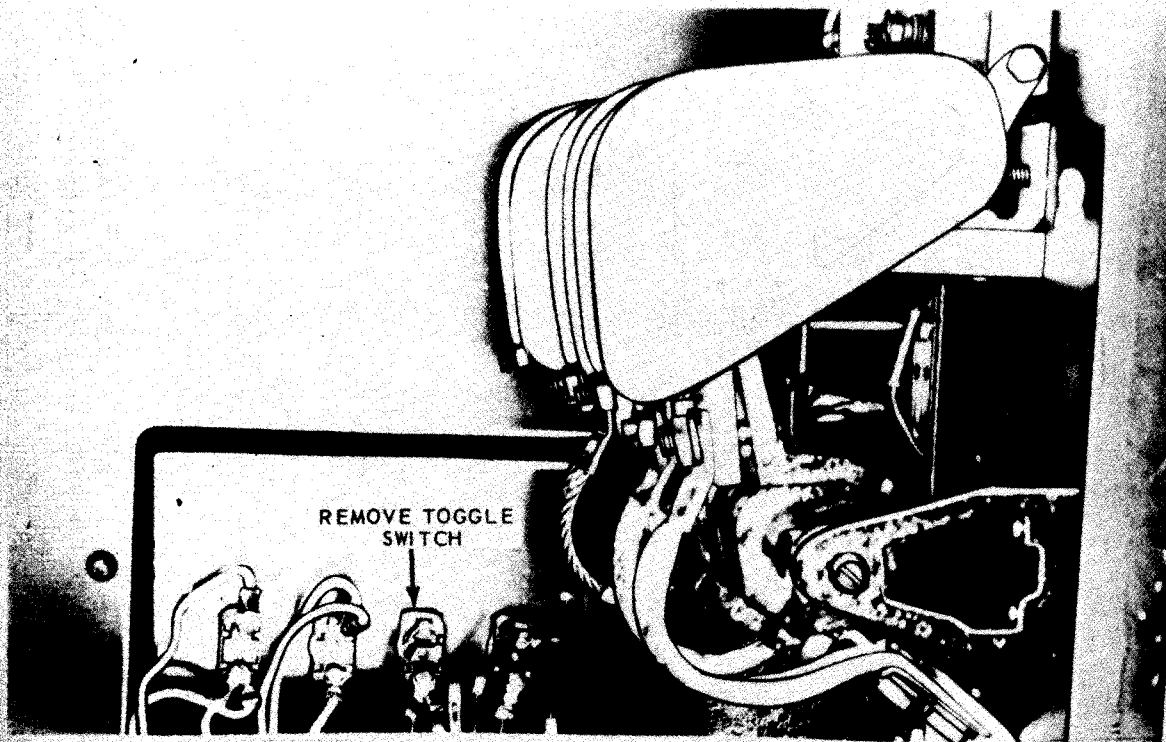

Figure 4-9. Synchronizer assembly power receptacle--connector, parallel receptacle-connector, bus bar and power leads, removal and installation. (Sheet 2 of 2).



A. FRONT VIEW OF CONTROL PANEL.

NOTE: TAG AND DISCONNECT ELECTRICAL LEADS AS REQUIRED.



B. REAR VIEW OF CONTROL PANEL.

NOTE: REMOVE AND INSTALL REMAINING TOGGLE SWITCHES (3) IN A SIMILAR MANNER.

ME 6115-376-13/4-10

Figure 4-10. Synchronizer assembly toggle switches, removal and installation.

REMOVE SCREW (10) AND  
REMOVE BACK COVER

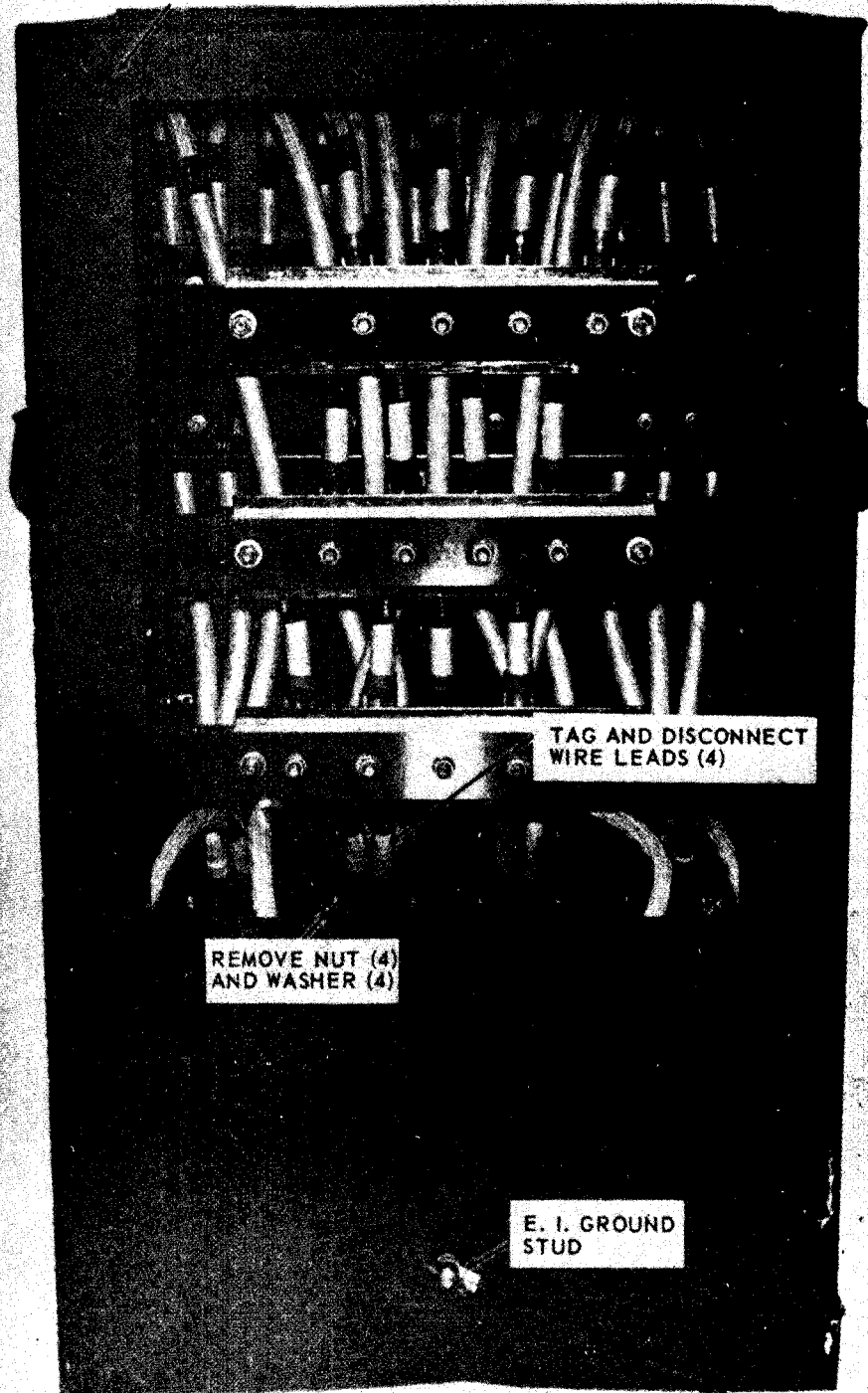

TAG AND DISCONNECT  
WIRE LEADS (4)

REMOVE NUT (4)  
AND WASHER (4)

E. I. GROUND  
STUD

GROUND CABLE TO  
TRAILER FENDER

ME 6115-376-13/4-11 ①

Figure 4-11. Connector-receptacle and cover (switchbox), removal and installation (Sheet 1 of 2).



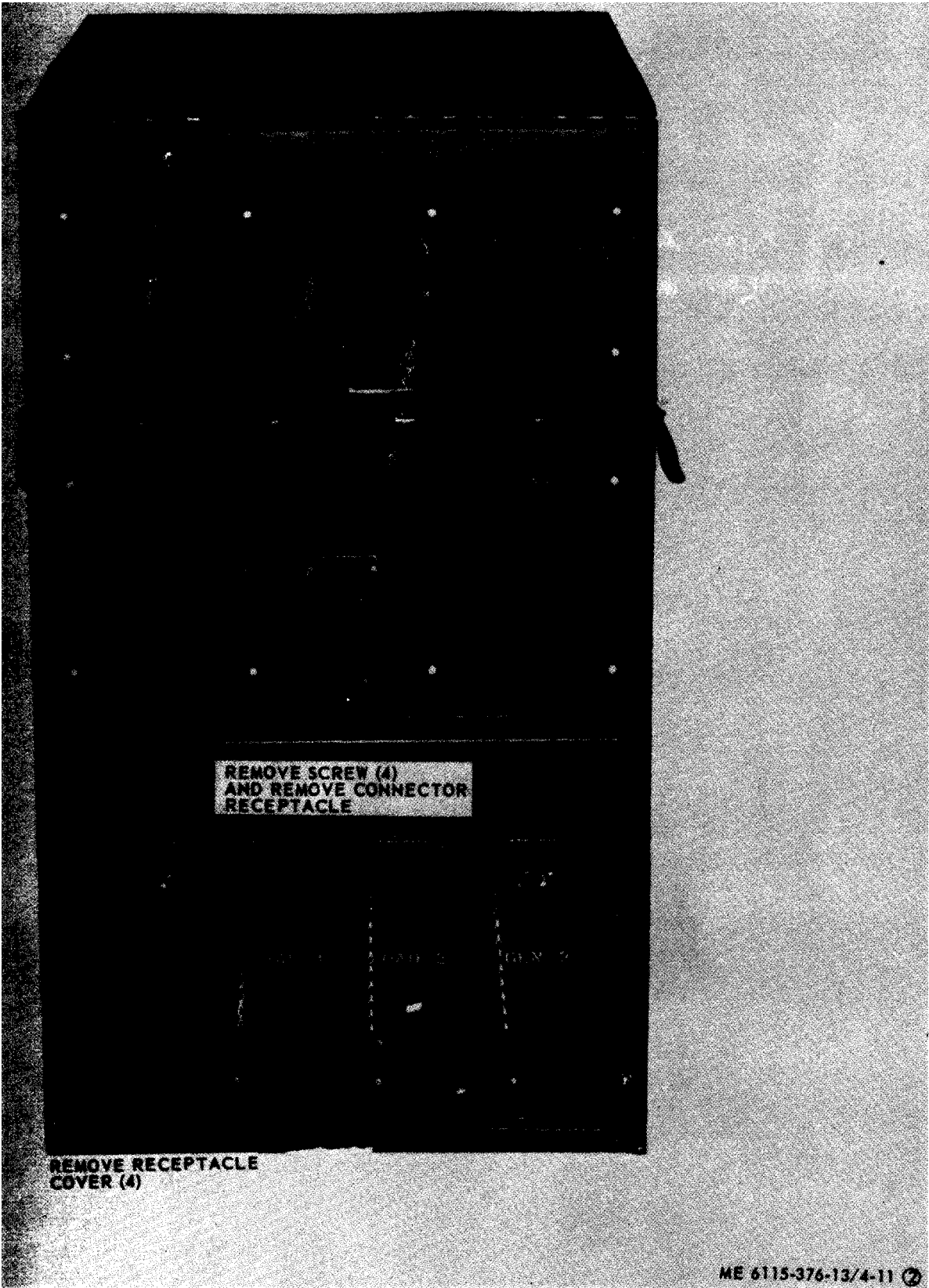

Figure 4-11. Connector-receptacle and cover (switchbox), removal and installation (Sheet 2 of 2).



CHAPTER 5

DIRECT SUPPORT MAINTENANCE INSTRUCTIONS

Section 1. REPAIR PARTS, SPECIAL TOOLS, AND EQUIPMENT

5-1. Tools and Equipment

Tools, equipment and repair parts issued with or authorized for the generator sets are listed in the basic issue items, Appendix C.

the general mechanics tool kit (FSN 5180-754-0641) are required, in addition to tools and equipment supplied with the generator sets or available at the direct support maintenance shop.

5-2. Special Tools and Equipment

There are no special tools or test equipment required for direct support maintenance. However, the standard multimeter TS-352/U (TM 11-5527) and AN/URM-105 (TM 11-6625-203-12), and

5-3. Maintenance Repair Parts

Repair parts and equipment are listed and illustrated in the repair parts and special tools list covering direct support maintenance for this equipment in TM 5-6115-376-23P.

Section II. TROUBLESHOOTING

5-4. Troubleshooting

a. For troubleshooting of the 45KW generator sets refer to TM 5-6115-239-10 or TM 5-6115-247-15, for the 60KW generator sets see TM 5-6115-425-12 and -35. Troubleshooting for the M200A1 trailer is covered in TM 9-2330-205-14,

and for the M54A2 cargo truck in TM 9-2330-211-10.

b. For troubleshooting of the distribution box, portable distribution boxes, synchronizer assembly or switchbox refer to table 5-1.

Table 5-1. Troubleshooting

Malfunction	Probable cause	Corrective action
1. Phase indicator lamps don't glow 2. Phase control switch faulty action 3. Phase meters not registering 4. Input or output power varies	<i>Distribution Box (All Units)</i> Defective bulb Excessive wear Meter-sticking, defective or loose connections Poor connections	Replace bulb (para 6-35) Replace switch (para 6-33) Check connections replace defective meter (para 6-3b) Check all connections, and condition of cables and connections, replace defective cable or connection.
1. Unit not receiving power 2. Indicator lamps inoperative 3. Circuit breaker switches faulty action 4. Duplex receptacles faulty connections	<i>Portable Distribution Box (All Units)</i> Faulty input power receptacle Faulty lamp or socket Worn or broken Worn or broken	Check condition; replace if defective (para 6-4) Replace bulb or socket (para 6-4). Replace (para 6-4) Replace (para 6-4)
1. Automatic switch fails to operate 2. Synchronizer fails to operate properly	<i>Synchronizer Assembly (PU-407/M)</i> a. Contacts chatter b. Excessive burn c. Contacts burnt excessively a. Defective module b. Defective transformer c. Loose terminal	a. Adjust controls (para 6-5) b. Clean magnet and magnet contact (para 6-5) c. Replace contacts (para 6-5) a. Replace synchronizer (para 6-5) b. Replace synchronizer (para 6-5) c. Tighten terminal

Table 5-1. Troubleshooting—Continued

Malfunction	Probable cause	Corrective action
3. Relay fails to operate properly	a. Breaker points stuck b. Transformer defective c. Loose connections d. Defective wiring	a. Replace relay (para 6-5) b. Replace relay (para 6-5) c. Tighten connections d. Replace wiring (para 6-7)
1. Circuit breaker switches fail to operate properly 2. Generator or load connector-receptacle inoperative	<i>Switchbox (PU-699/M)</i> Worn or broken switch  Worn, cracked or broken input receptacle; or loose wiring	Replace switch (para 6-6).  Check wires; replace a defective connector-receptacle (para 6-6)

### Section III. GENERAL MAINTENANCE

#### 5-5. General Maintenance

For general maintenance instructions covering the diesel engine generator sets refer to TM 6-6115-239-10, or TM 5-6115-247-15 (45KW

units), or to TM 5-6115-42-12 (60KW units). Refer to TM 9-2330-205-14 for the M200A1 generator trailer, and to TM 9-2320-211-10 for general maintenance of the M54A2 cargo truck.

### Section IV. REMOVAL AND INSTALLATION OF MAJOR COMPONENTS AND AUXILIARIES

#### 5-6. Distribution Box Assembly

a. Disconnect power cable and ground strap from distribution box.

b. On PU-407/M and PU-699/M trailer units remove mounting hardware from under fender securing distribution box to fender.

c. On PU-408/M and PU-700/M cargo truck **remove** mounting hardware from under skid platform securing distribution box to skid.

d. Remove support brace (fig. 1-3(1) from mounting bracket on side of distribution box.

e. With suitable lifting device, lift distribution box from trailer fender of PU-407/M or PU-699/M unit (or from skid platform of PU-408/M or PU-700/M).

f. Install replacement distribution box on trailer or truck in reverse order of removal.

#### 5-7. Synchronizer-Assembly (PU407/M)

a. Loosen turnbuckles of hold-down assemblies until hooks can be disengaged.

b. Remove cables from synchronizer assembly and install covers on connection.

c. With adequate lifting device, lift synchronizer assembly from its base mounting frame on trailer fender.

d. Install replacement synchronizer assembly in reverse order of removal.

#### 5-8. Switchbox (PU-699/M)

a. Disconnect cables from switchbox, and install covers on connector-receptacle.

b. Loosen turnbuckles of holddown assemblies until hooks can be removed from handles of switchbox.

c. With adequate lifting device, lift switchbox from its mounting base on trailer fender.

d. Install replacement switchbox in reverse order of removal.

#### 5-9. Diesel Engine Generator Set

**NOTE**

To remove diesel engine generator unit from the generator trailer or truck, four men and a device capable of lifting 5,000 pounds are required

a. **Removal Front Generator Trailer (PU407/M, PU-699/M).**

(1) Lower front and rear landing legs and set trailer handbrakes.

(2) Remove distribution box (para 5-6), synchronizer assembly (PU-407/M, para 5-7) (or switchbox, PU-699/M, para 5-8), portable distribution boxes, cable reels, fuel cans, fire extinguishers, and portable accessory boxes from their mounting brackets on trailer.

(3) Remove bolts holding DE generator unit skid base to trailer frame.

(4) Remove DE generator unit mounting support pins from DE generator unit skid base.

(5) Remove output cable from panel connections of generator set, and cable from distribution box.

(6) Place hook of lifting device in lifting ring at top center of DE generator unit and slowly lift the DE generator unit from the trailer.

*b. Installing Replacement DE Generator Unit on Trailer.*

(1) Be sure trailer is parked on a firm and level area; front and rear landing legs lowered; trailer hand brakes set, and loose tools and mounting hardware removed from trailer frame.

(2) Lower and guide generator unit onto trailer frame. Aline mounting holes in skid base with appropriate mounting holes in trailer frame. Insert bolts and DE generator mounting support pins in place and secure. Remove lifting device.

(3) Install power outlet cable, distribution box and its power cable, synchronizer assembly (PU-407/M) or switch box (PU-699/M), cable reels, fuel cans, portable distribution boxes and portable accessory box to their respective mounting brackets on trailer.

*c. Removal From Skid Platform (PU-408/M, PU-700/M).*

(1) Remove distribution box (para 5-6), fuel cans, fire extinguisher, portable distribution boxes and portable accessory box from skid platform.

(2) Remove the 18 cable reels and six hold-down rods from skid platform.

(3) Remove power cables from generator set and distribution box.

(4) Remove bolts holding DE generator unit to skid platform.

(5) Place hook of lifting device in lifting ring at top center of DE generator unit and slowly lift DE generator unit clear of skid platform. Do not allow unit to swing freely.

(6) Drive cargo truck from under DE generator unit.

*d. Installing Replacement DE Generator Unit on Truck.* To install DE generator unit on skid platform, four guide bolts 5/8-11 x 7-1/2 inches long should be used,

(1) See that truck is parked on a level area and that skid platform is free of loose hardware.

(2) Using lifting device attached to lifting ring of DE generator unit, lower and guide DE generator unit to approximately six inches above skid platform.

(3) Insert the four guide bolts (fig. 5-1) through DE generator unit skid base. Aline the four guide bolts over skid platform mounting holes.

(4) Slowly lower DE generator onto skid platform. Place nuts and washers on guide bolts and tighten securely.

(5) Install distribution box, portable distribution boxes, fuel cans, fire extinguishers, portable accessory box onto their respective mounting bases. Install power cable to DE generator and distribution box. Install cable reels and hold-down rods.

## 5-10. Skid Platform (PU-408/M, PU-700/M)

*a. General.* To remove the skid platform after the DE generator unit and all ancillary items (para 5-9) have been removed, four men and a lifting device of 5,000 pound capacity are required. To remove a fully equipped platform, four men and a 10,000 pound capacity lifting device are required.

*b. Removal.* Release each skid platform hold-down assembly (fig. 5-2), and attach sling assembly to lifting eyes (fig. 5-3) as follows:

(1) Loosen bracket clamping bolt until free of platform bracket assembly.

(2) Remove vertical adjustment bolts.

(3) Slide adjustable bracket assembly and clamp to one side of platform bracket assembly.

(4) Loosen horizontal adjustment bolts and slide platform bracket assembly away from side of cargo body.

(5) Connect sling assembly and lifting bar to skid platform as shown in figure 5-3.

### NOTE

When lifting a fully equipped skid platform, adjust turnbuckles on the two front sling leg cables to compensate for unequal weight distribution

(6) Lift skid platform and adjust turnbuckles until skid platform is level.

(7) Raise skid platform and drive truck out from underneath it.

*c. Installation.* Install skid platform to truck and secure each hold-down assembly as follows:

(1) Connect sling assembly and lifting bar to skid platform (fig. 5-3).

(2) When installing a fully equipped skid platform lift the skid platform and adjust turnbuckles on the two front sling leg cables until the skid platform is level.

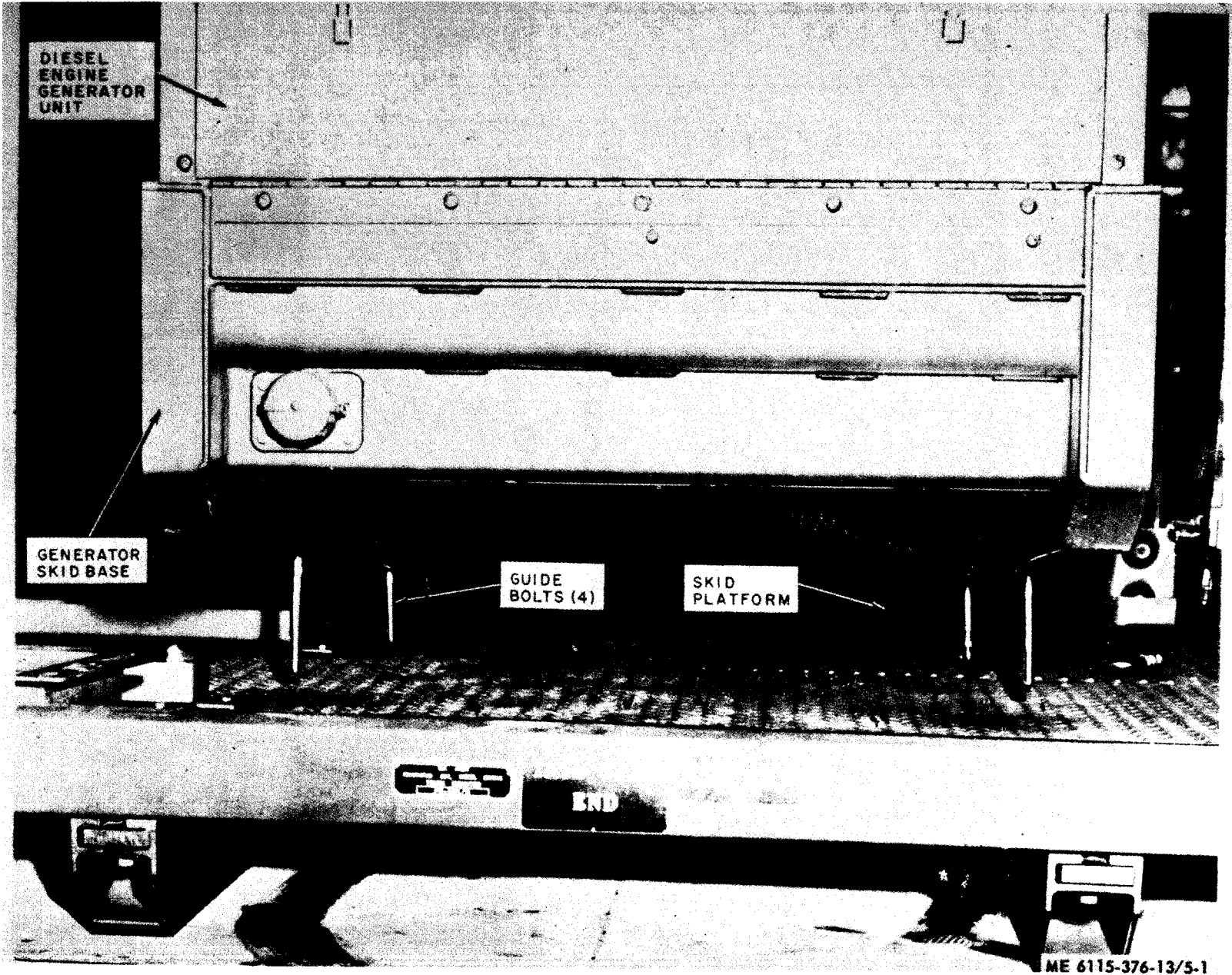

Figure 5-1. Lowering of DE generator unit into skid platform.

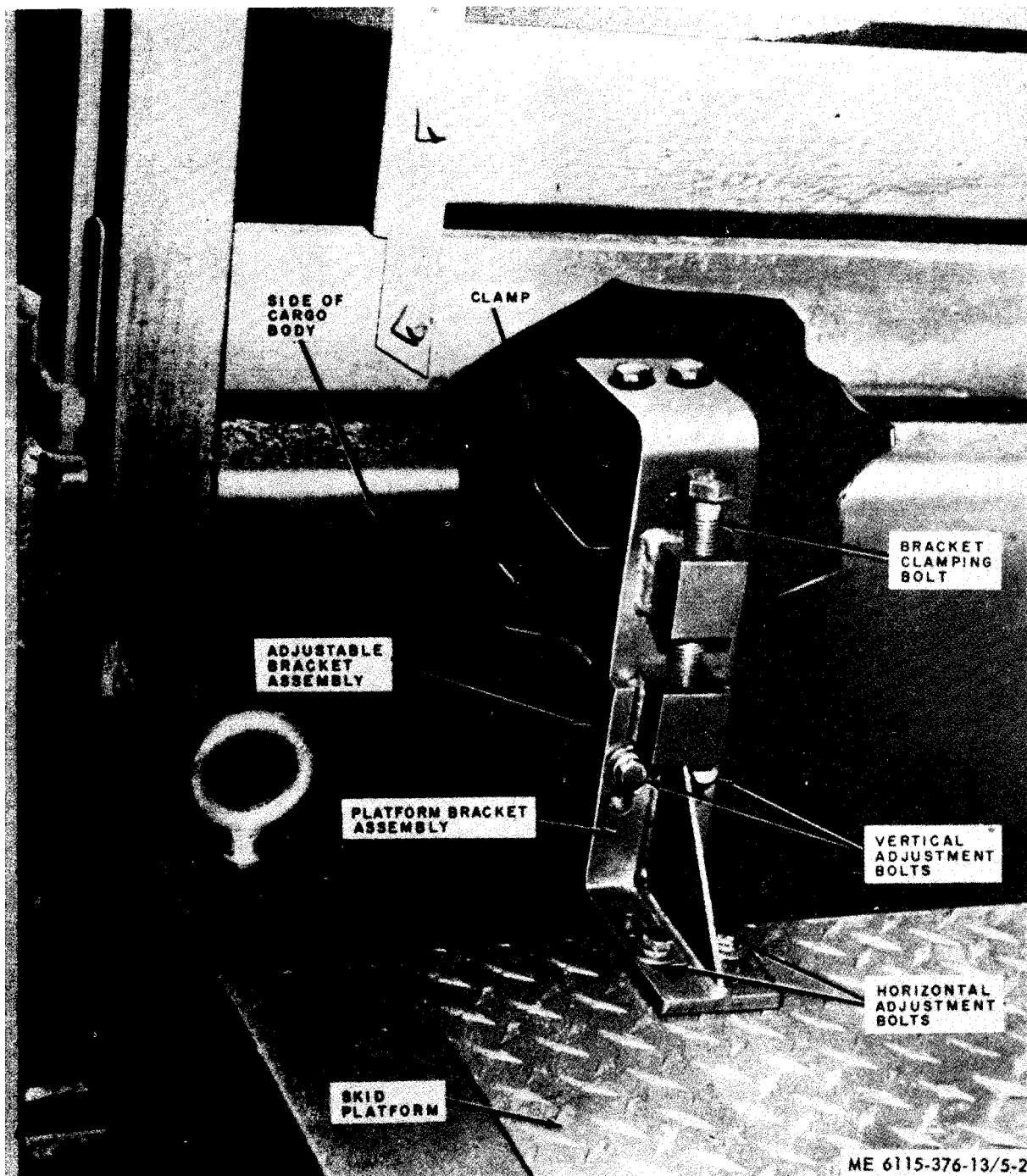

Figure 5-2. Skid platform holddown assembly.

(3) Lower truck tailgate; raise skid platform and back truck underneath skid.

(4) Lower and guide skid platform onto truck cargo bed. Before removing sling assembly, inspect to see that skid platform does not interfere with closing of truck tailgate.

(5) Aline adjustable bracket assembly and clamp with platform bracket assembly.

(6) Slide platform bracket assembly toward side of cargo body. Turn clamping bolt until it engages threads in platform bracket assembly.

(7) Tighten horizontal bolts. Install and tighten vertical adjustment bolts.

(8) Tighten bracket clamping bolt fully, and inspect all bolts to see they are secure. Should now look as shown in figure 5-4.

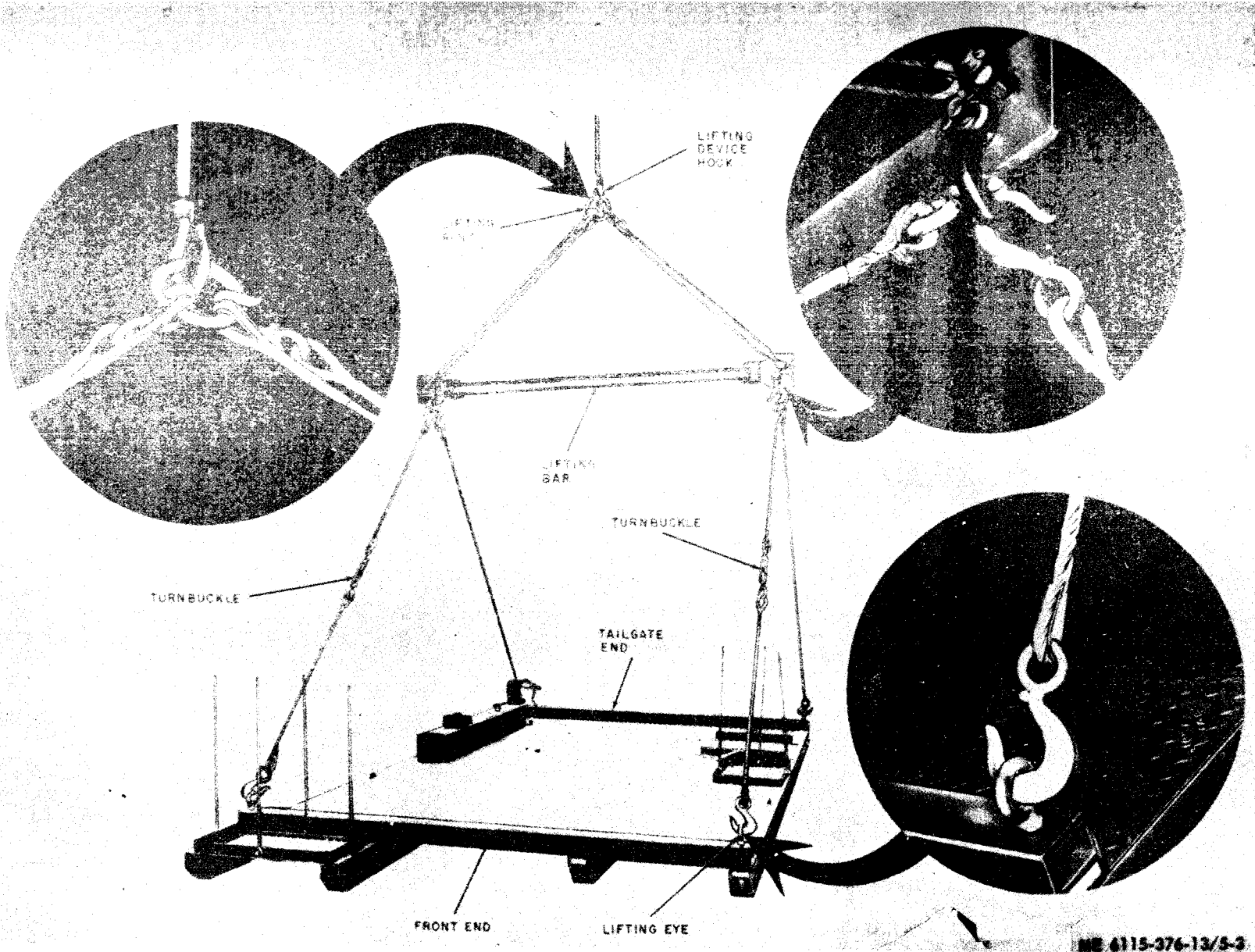
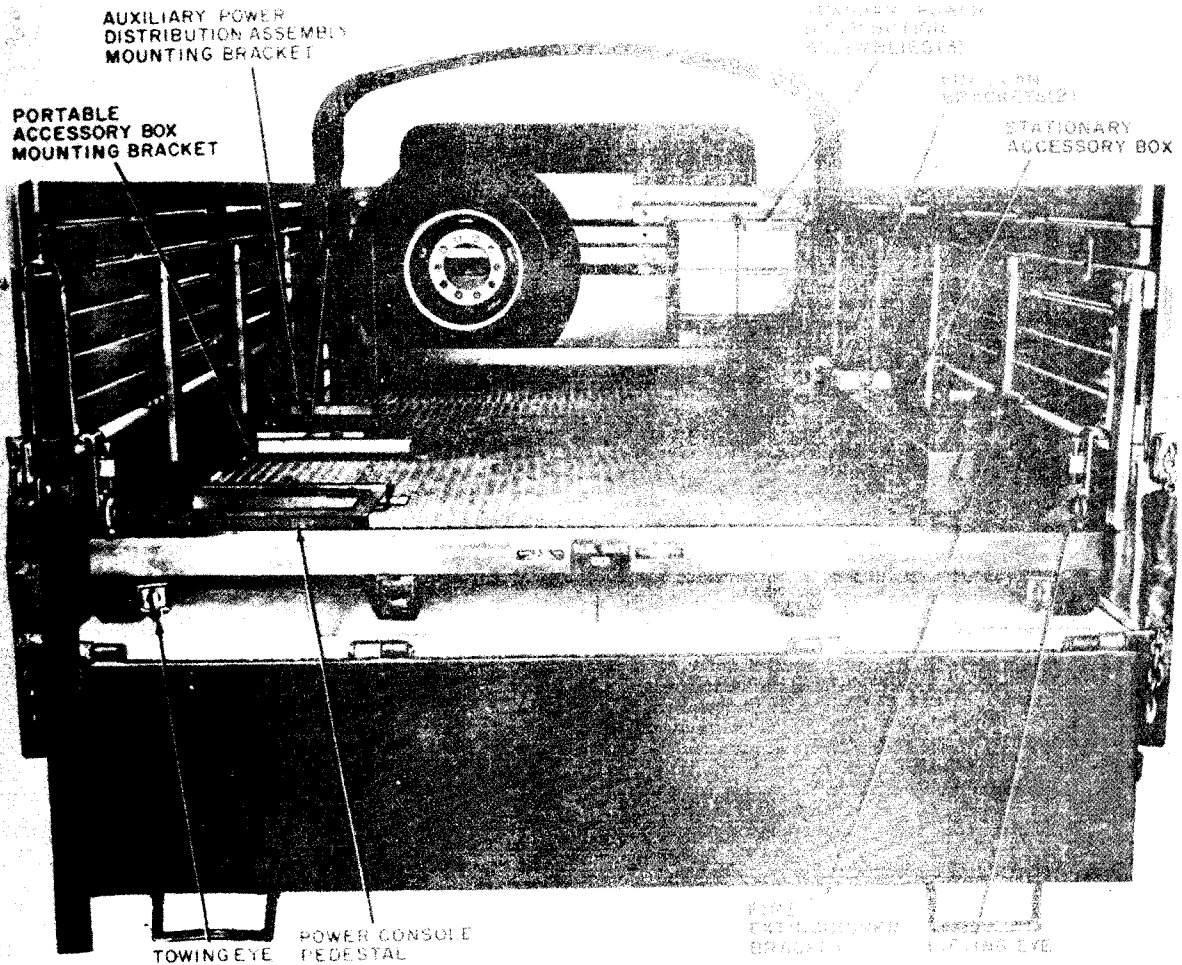

Figure 5-3. Lifting sling assembly in use.





ME 6115-376-13/5-4

Figure 5-4. Skid platform, ready for mounting of 100 generator suit.



## CHAPTER 6

### REPAIR INSTRUCTIONS

---

#### Section I. REPAIR OF GENERATOR SETS, CARGO TRUCKS AND TRAILERS

##### 6-1. Generator Sets

For repair of the 45KW generator sets refer to TM 5-6115-239-10, 20, and 35 (Model 4070), or to TM 5-6115-247-15 and 35 (Model 54400). For the 60KW generator set repair instructions, refer to TM 5-6115-425-12 and 35.

##### 6-2. Trailer and Truck

For repair of the M200A1 trailer used with the PU-407/M and PU-699/M generator sets, refer to TM 9-2330-205-14, For repair of the M54A2 truck used with the PU-408/M and PU-700/M generator sets, refer to TM 9-2320-211-10.

#### Section II. REPAIR OF DISTRIBUTION BOX, PORTABLE DISTRIBUTION BOXES, SYNCHRONIZER ASSEMBLY, SWITCHES AND WIRING

##### 6-3. Distribution Box

###### *a. Circuit Breakers, Removal and Installation.*

###### *NOTE*

See MERDC drawing 13214E1365 for latest configuration for PU-407/M and PU-408/M; and to 13216E7470 for PU-699/M and PU-700/M.

(1) If necessary, remove distribution box from trailer or truck (para 5-6).

(2) Release captive screw at top corners of distribution panel and secure panel in open position (fig. 6-1).

(3) With screwdrivers on clip at top of defective circuit breaker, pry out on clip at top and bottom until center clip is clear of bus bar.

(4) Unscrew screw at bottom of circuit breaker and pull out the two wire leads.

(5) Place wire leads ((4) above) in position on replacement circuit breaker and tighten holding screw.

(6) Snap replacement circuit breaker into place on panel (see that clip is fully engaged at top and bottom).

(7) Close panel and secure captive screws.

*b. Ammeters, Removal and Installation.* To replace faulty ammeters, open distribution panel (a(2) above). Tag and remove wire leads and nuts (fig. 6-1); remove nuts holding meter to panel, (Remove meter from back side; bezel from front side). Put replacement meter into panel, add bezel and secure the 3 screws holding meter to panel. Replace wire leads and attaching hardware, Close and secure control panel.

*c. Lump Socket Assemblies, Removal and Replacement.*

(1) Open distribution panel (a(2) above).

(2) Unsolder all leads of the defective socket assembly (open laced cable if necessary).

(3) Unscrew lens from face of panel, remove lens and bayonet-type bulb, and unscrew threaded collar holding socket to face of panel, and remove collar.

(4) Unscrew and remove nut, lockwasher and flatwasher from back side of panel, and remove defective lamp socket assembly.

(5) Place replacement lamp socket assembly in panel; screw on threaded collar on face of panel, and flatwasher, lockwasher and nut to back of panel, draw nut up securely. Solder leads in same order as removed; add bulb and lens to face of panel (fig. 6-2).

*d. Distribution Panel, Removal and Installation.* To replace a worn or damaged distribution panel, proceed as follows:

(1) Prop cover in open position and open distribution panel (fig. 6-2 and 6-3).

(2) Remove screws and ammeter, bezels, lens, bulbs and collars from face of panel (fig. 6-3).

(3) Remove nuts and washers and pull lamp socket assemblies from panel. Also pull ammeters from panel, Allow ammeters and lamp sockets to hang gently from wiring harness.

(4) Remove attaching hardware from chain (fig. 6-2), and remove attaching hardware from bottom of panel (fig. 6-3). Remove panel.

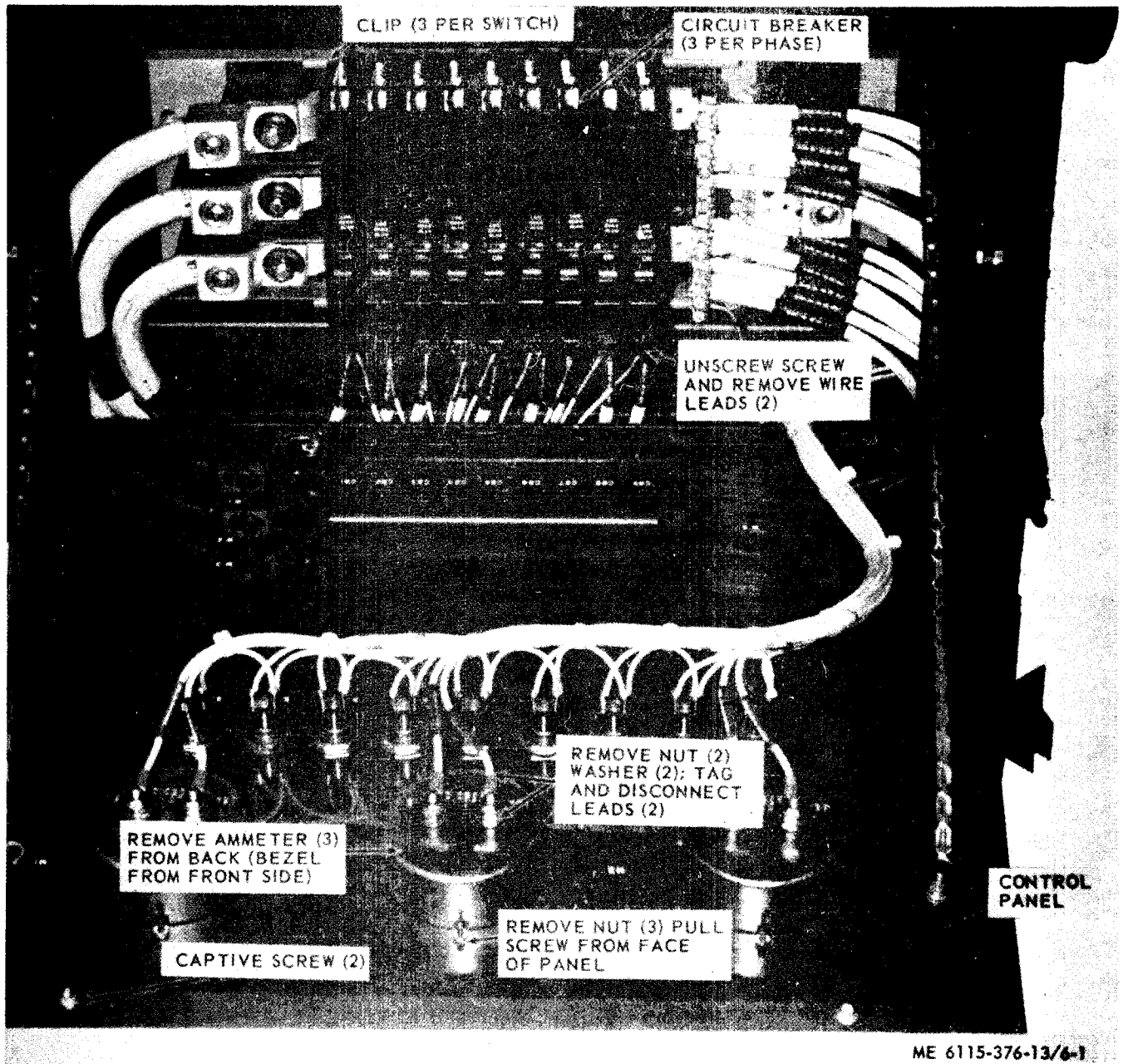

Figure 6-1. Distribution box circuit breakers and ammeters, removal and installation.

(5) Place replacement distribution box, and install form mounting screws ( fig. 6-3) to hold panel to distribution box. Attach chains to panel. Gently install ammeters and lamp socket assemblies into proper position and secure with attaching hardware (fig. 6-1, 6-2 and 6-3). Check that all lamps are secure.

*e. Current Transformers, Removal and Installation.*

(1) Remove back cover plate from distribu-

tion box and cut plastic straps on transformer wiring.

(2) Refer to figure 6-4 and remove load line from transformer loop; remove wire leads from T32 and remove current transformer and bracket,

(3) Place replacement current transformer in bracket, and install in distribution box, Place load line through transformer loop and recommend to TB1 load connection panel. Attach two leads of new transformer to TB2; add plastic straps as required.

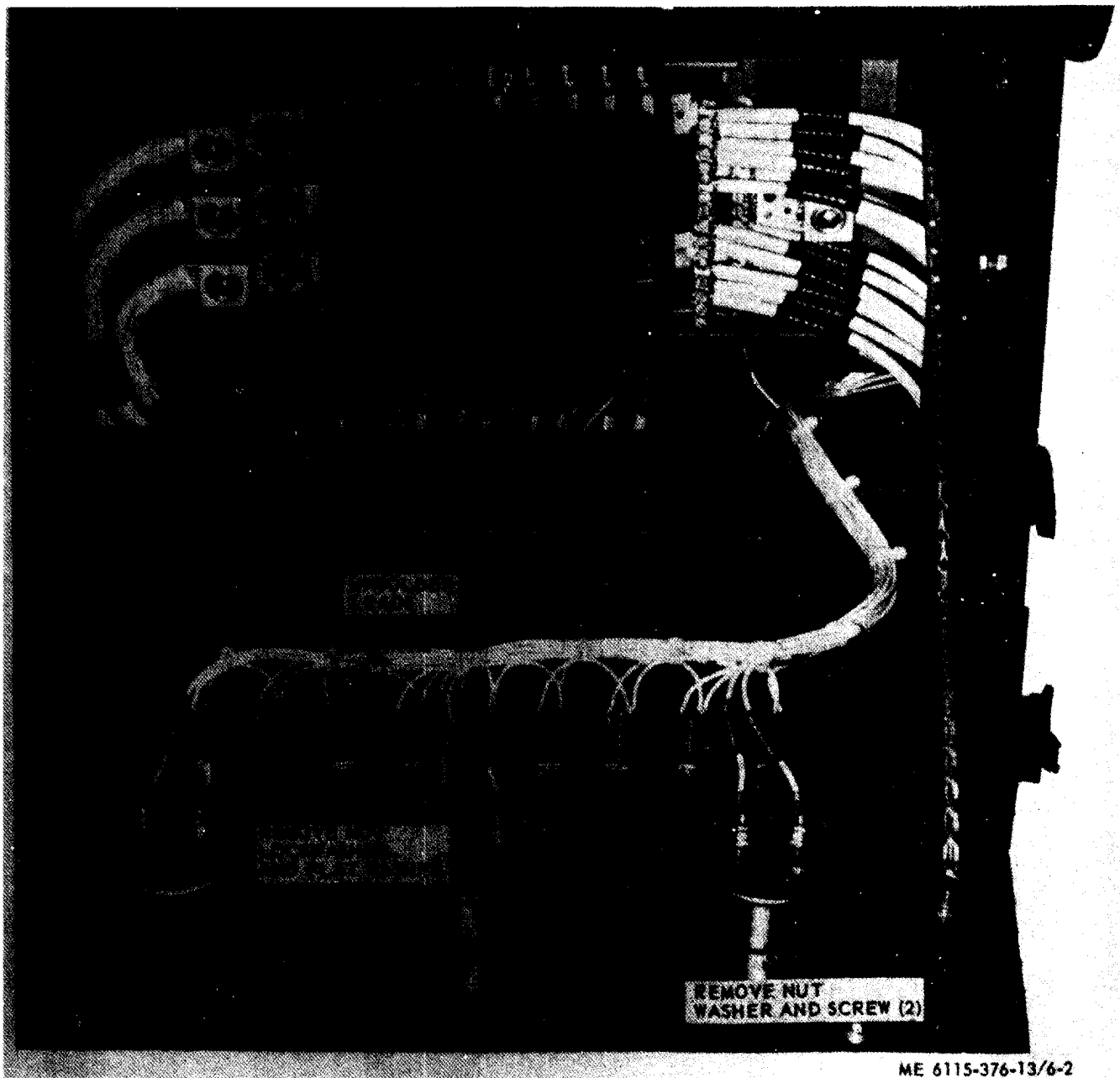

Figure 6-2. Lamp socket assemblies and chain removal and installation (distribution box, all units).

#### 6-4. Portable Distribution Boxes (All Units)

*a. Circuit Breaker Switches.* The six circuit breaker switches of the portable distribution box are of similar snap on and off design as those of the console distribution box, and are removed and installed in a similar manner (para 6-3a).

*b. Lamp Socket Assemblies.* The six lamp socket assemblies, lens, bulbs, and mountings of the portable distribution box are of the same size

and mountings as those of the console distribution box. They are removed and installed in a similar manner (para 6-3c).

*c. Duplex Power Receptacles, Removal and Installation.* Refer to figure 6-5 and remove duplex receptacle from panel. Place replacement duplex receptacle in position on panel, add attaching hardware; connect wire leads (add circuit breaker bracket to panel if removed); install panel into portable distribution box.

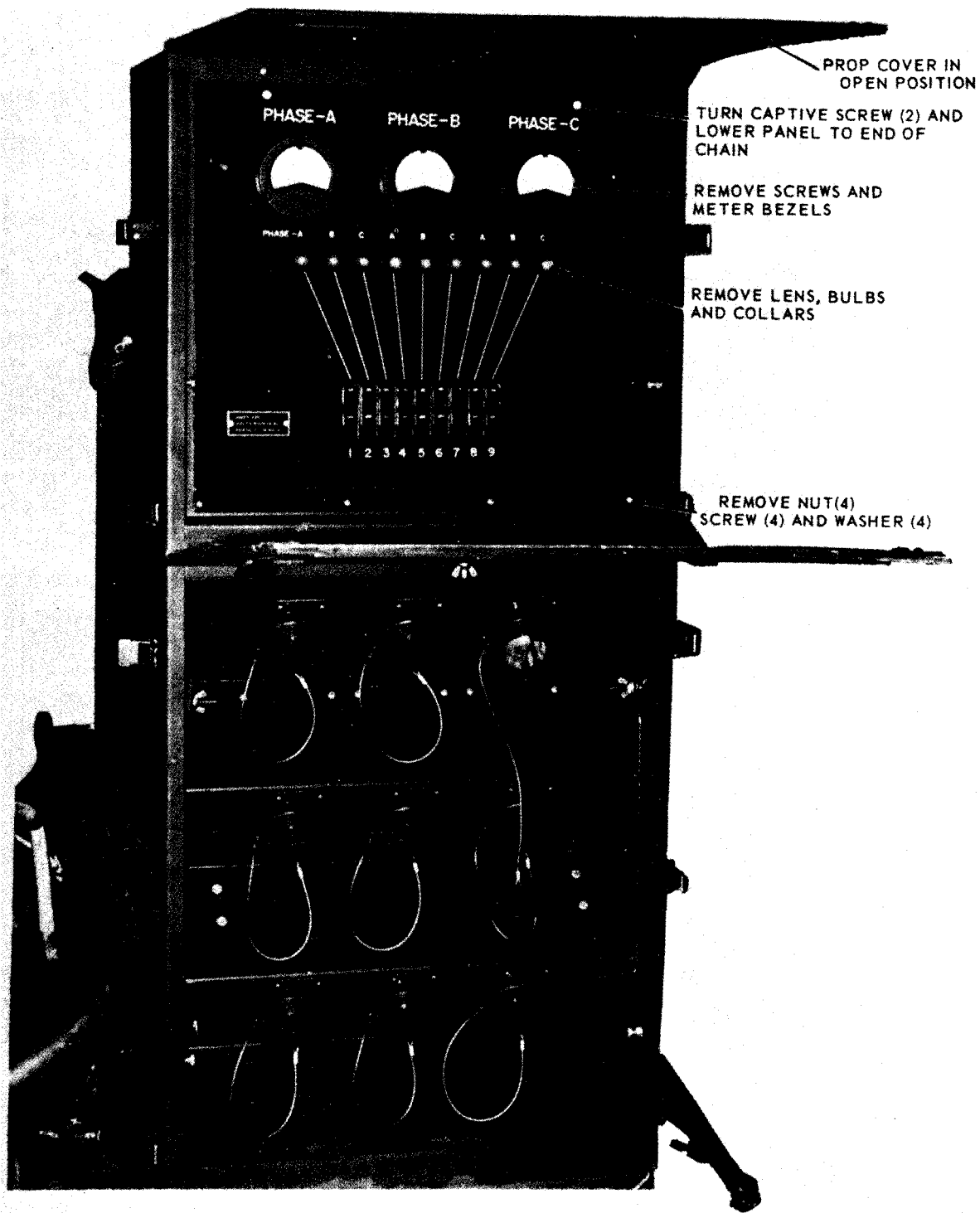

ME 6115-376-13/6-3

Figure 6-3. Distribution panel, removal and installation (all units).

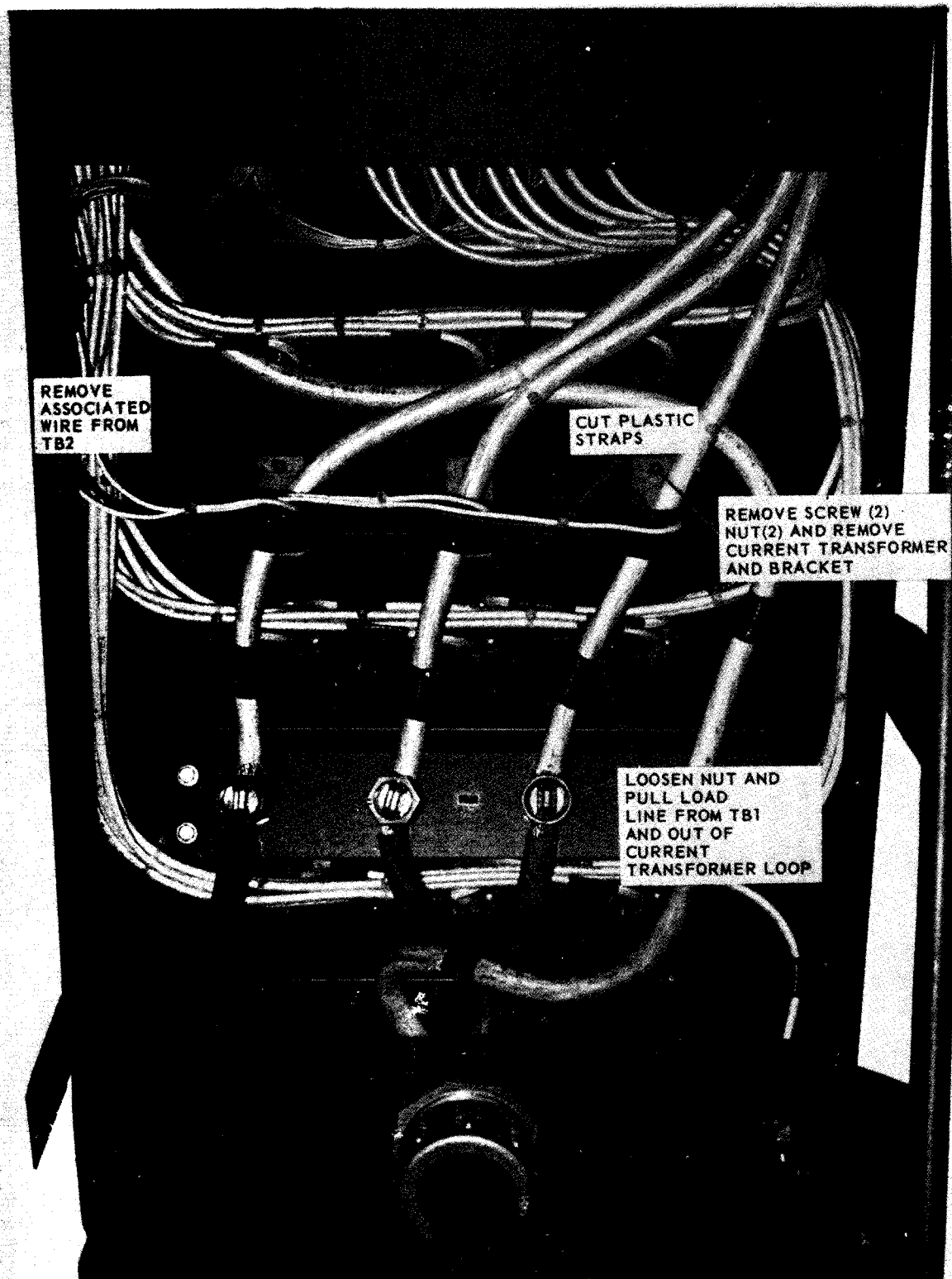

ME 6115-376-13/6-4

Figure 6-4. Current transformers, removal and installation (distribution box, all units).

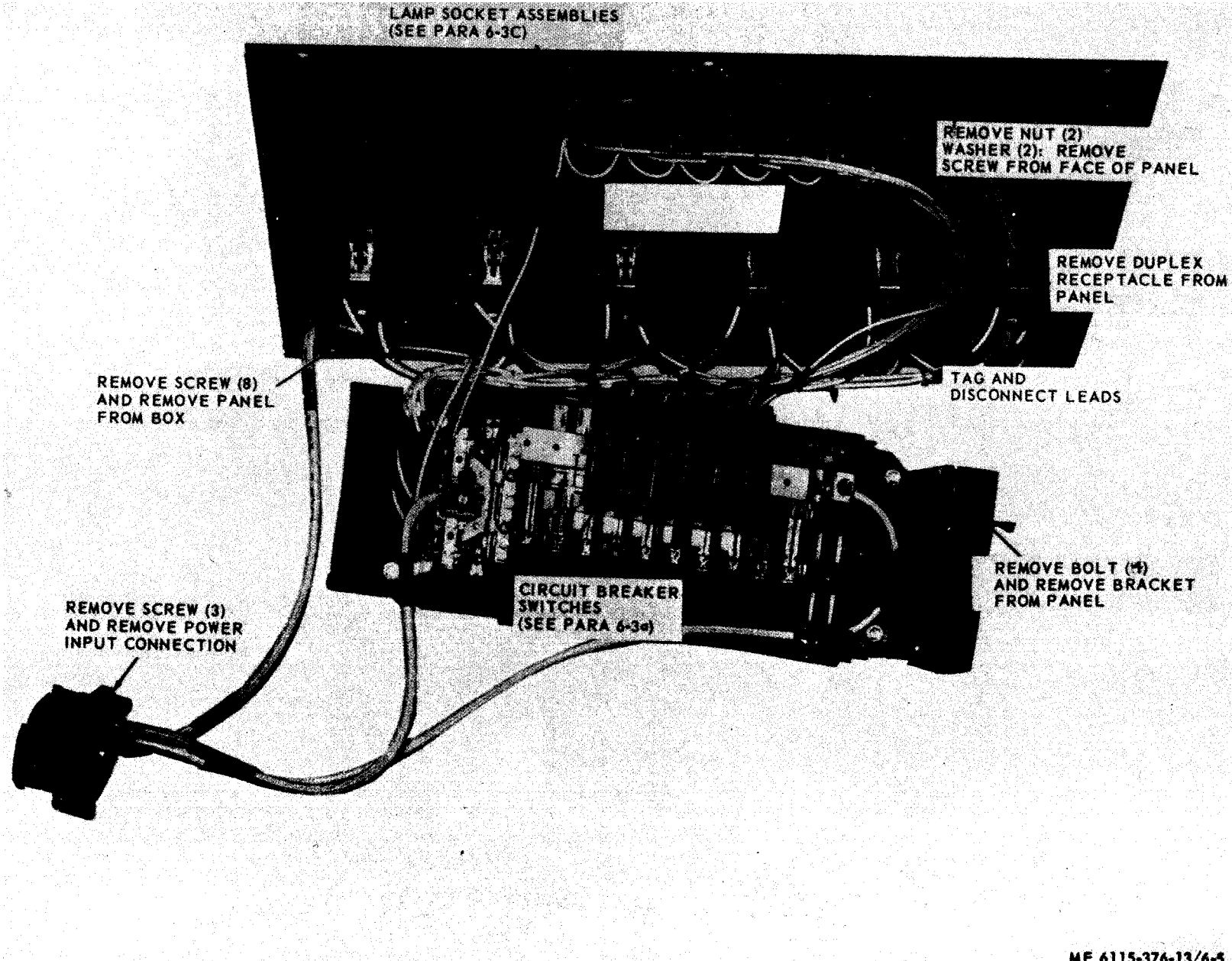

ME 6115-376-13/6-5

Figure 6-5. Portable distribution box panel components, removal and installation.



### 6-5. Synchronizer Assembly (PU-407/M)

*a. General.* The synchronizer assembly is mounted on the roadside fender of the PU-407/M. It is used to operate the PU-407/M and PU-408/M singly, alternately, or in parallel.

*b. Automatic Switch, Removal and Installation.* Remove rear access panel; refer to figure 6-6 and remove the automatic switches. Install replacement automatic switch in reverse order of removal.

*c. Automatic Switch Disassembly.* Refer to figure 6-7 and perform in the following:

- (1) Remove nuts (13), washer (12), screws (1), and disassemble support shield (2), shield (3), spacer (43), and insulation (8).
- (2) Remove nut (41), washer (42) and (10), and bolt (11).
- (3) Unscrew bolt (11) and remove coil (9) and washer (10).

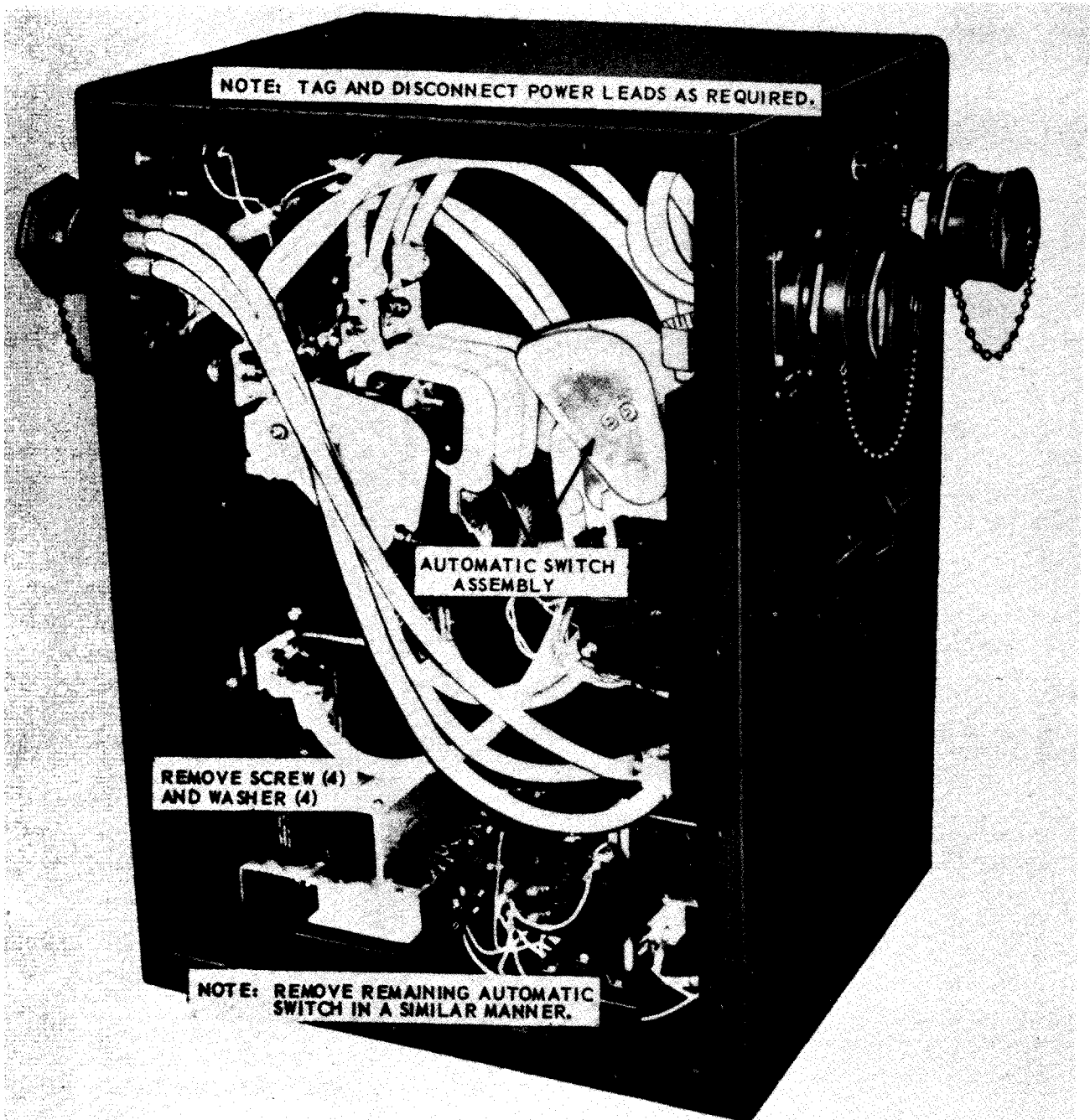
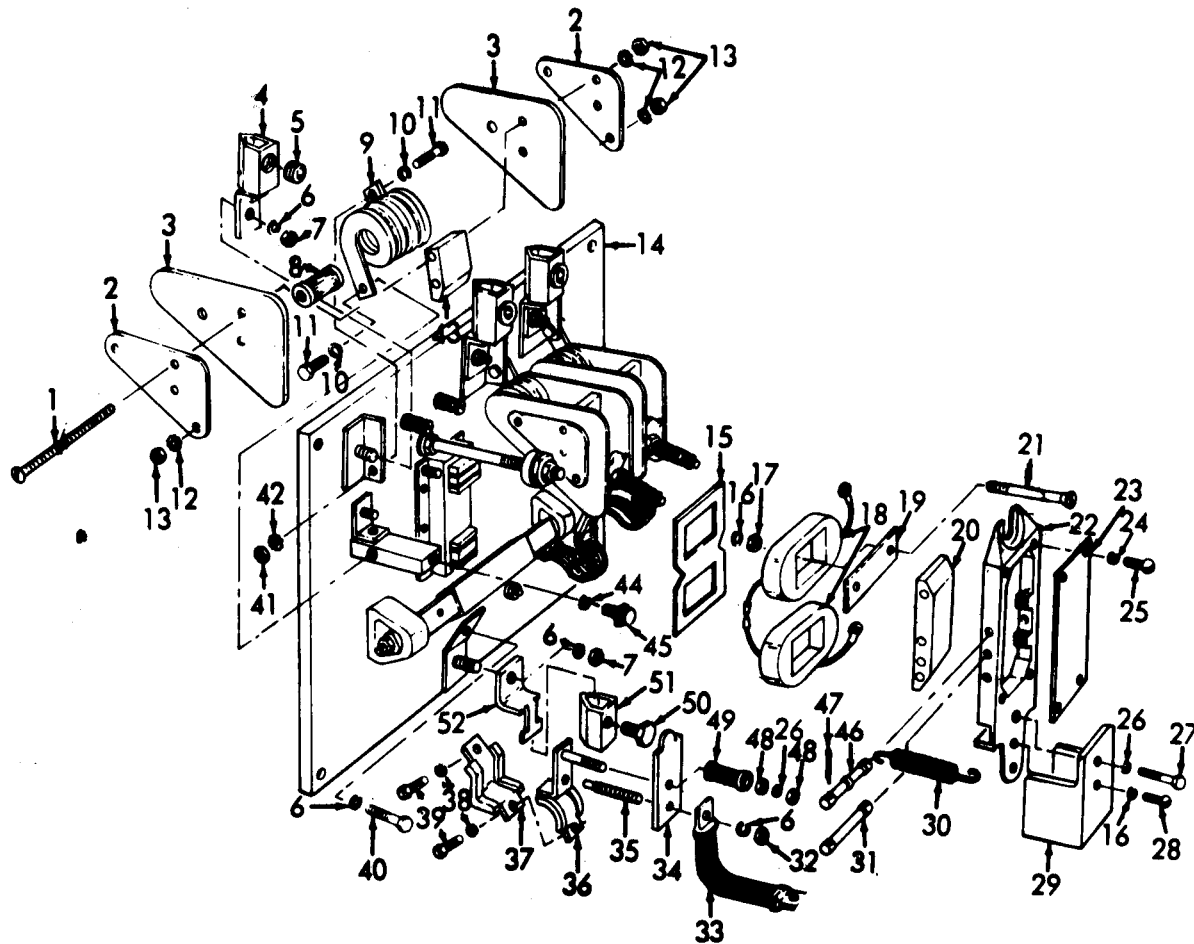

Figure 6-6. Automatic switch assembly, removal and installation.

(4) Unscrew setscrew (5) from terminal (4). Unscrew nut (7) and remove terminal (4) and washer (6).

(5) Unscrew capscrew (50) from terminal (51), and remove terminal (51) from terminal bracket (52). Unscrew nut (7) and remove washer (6) and terminal bracket (52).

(6) Disconnect magnet opening return spring (30) from magnet retainer (22) and stud mounted in terminal board. Unscrew capscrew (27) attaching counterweight (29) and magnet retainer (22) to axle mounted on terminal board. Tag and disconnect two electrical leads from coil assembly (18). Remove screw (21), coil retaining plate (19), and coil assembly (18).



ME 6115-376-13/6-7

- |                    |                    |              |
|--------------------|--------------------|--------------|
| 1. Screw           | 18. Coil Assembly  | 36. Bracket  |
| 2. Support         | 19. Plate          | 37. Cap      |
| 3. Shield          | 20. Magnet         | 38. Washer   |
| 4. Terminal        | 21. Screw          | 39. Bolt     |
| 5. Setscrew        | 22. Retainer       | 40. Bolt     |
| 6. Washer          | 23. Cover          | 41. Nut      |
| 7. Nut             | 24. Washer         | 42. Washer   |
| 8. Insulator       | 25. Screw          | 43. Spacer   |
| 9. Burmont coil    | 26. Washer         | 44. Washer   |
| 10. Washer         | 27. Screw          | 45. Stud     |
| 11. Bolt           | 28. Screw          | 46. Pin      |
| 12. Washer         | 29. Counterweight  | 47. Pin      |
| 13. Nut            | 30. Spring         | 48. Nut      |
| 14. Terminal Board | 31. Pin            | 49. Spring   |
| 15. Gasket         | 32. Nut            | 50. Capscrew |
| 16. Washer         | 33. Cable Assembly | 51. Terminal |
| 17. Nut            | 34. Point          | 52. Bracket  |
|                    | 35. Pin            |              |

Figure 6-7. Automatic switch disassembly and reassembly.

(7) Remove locknut (48), washer (26), nut (48), and spring assembly (49). Remove nut (32), washer (6), lead cable (33), and movable contact point (45), and remove washer (44) from point mounting post mounted on terminal board.

*d. Automatic Switch, Inspection, Repair and Reassembly.* Inspect all parts for cracks, breaks, damaged threads, cracked, broken or damaged insulation or other obvious defective parts. Repair or replace defective parts as necessary. Reassemble automatic switch in reverse order of disassembly (para 6-5(c)).

*c. Automatic Switch, Adjustment.* Refer to figure 6-8 and perform the following:

(1) Adjust open contact gap to 5/8-inch by turning nut on armature stop screw in or out.

(2) Adjust back finger gap between contact finger and contact arm to 1/4-inch by turning back finger pin in or out.

(3) Closed contact deflection should be 1/16-inch manual. All contacts must make and break simultaneously.

*f. Relay Switch.* The synchronizer assembly contains two relay switches each having a two-fold purpose of acting as a safety device for the automatic switch, and to regulate flow of current to the electromagnet on the automatic switch to permit the electronic synchronizer for generator

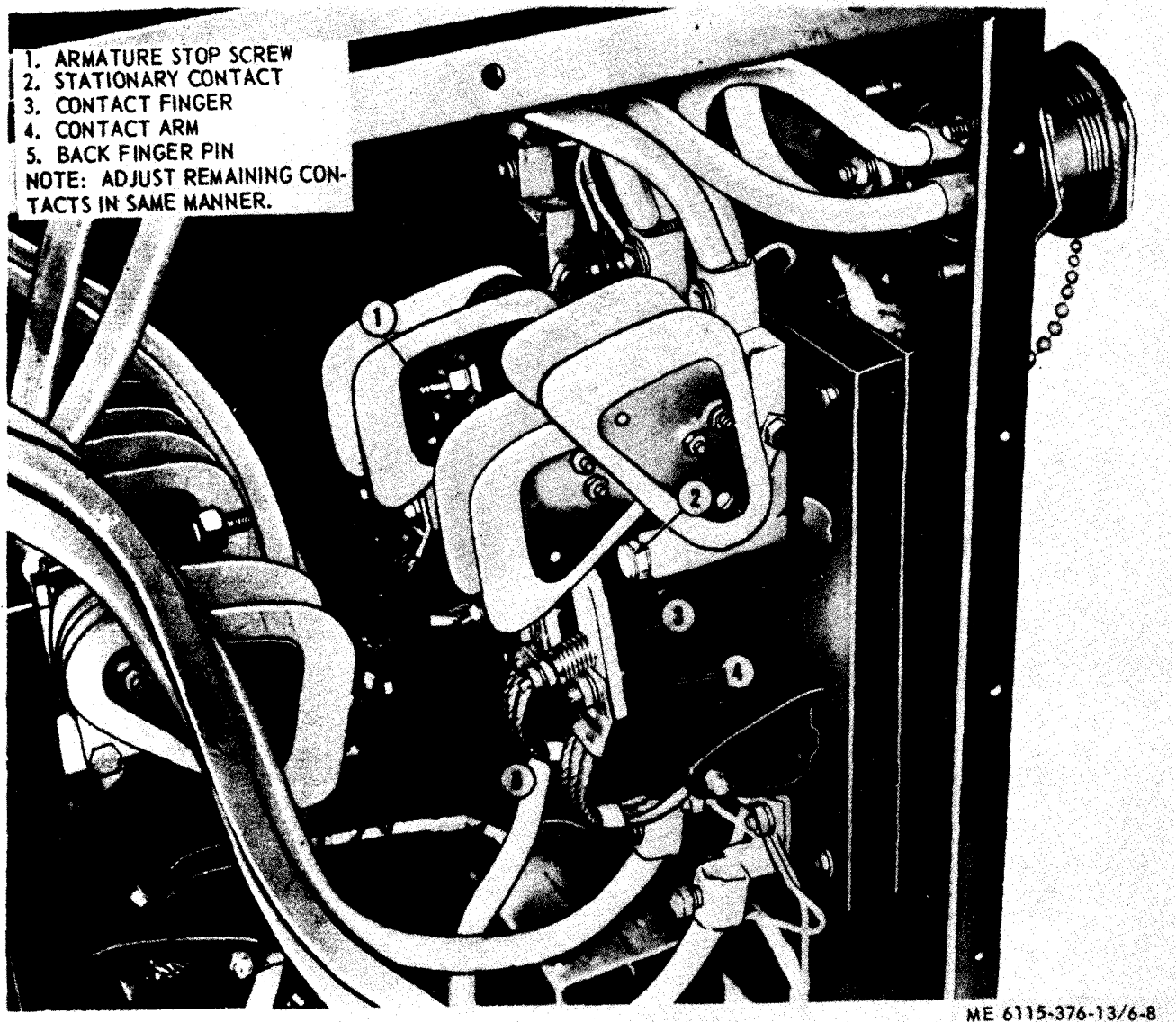

Figure 6-8. Automatic switch adjustment.

number one to operate until generator number two is put on the line.

*g. Relay Switch Removal, Inspection and Installation.* Remove rear access panel, refer to figure 6-9, tag and disconnect electrical leads as necessary; remove four mounting screws and remove relay switch. Inspect all parts for damaged threads, cracks, breaks or other obvious defects. Replace a defective relay switch. Install relay switch in reverse order of removal; install rear access panel.

*h. Electronic Synchronizer Switch.* The synchronizer assembly contains two electronic synchronizer switches of solid state design each consisting of three plug-in type modules, two transformers, transistors, diodes and capacitors. Remove rear access panel. Refer to figure 6-9, tag and disconnect electrical leads; remove two mounting screws and remove electronic synchronizer. Inspect all parts for cracks, breaks, loose connections, and other obvious defects. Replace a

defective electronic synchronizer switch. Install electronic synchronizer switch in reverse order of removal (fig. 6-9). Install rear access panel.

### 6-6. Switchbox (PU-699/M)

*a. General.* The switchbox is mounted on the roadside fender of the PU-699/M. Its purpose is to connect 3-phase power from one of two power sources (PU-699/M or PU-700/M, 60KW, generator sets) to a load. The power cable of the PU-699/M is connected to Gen 1 of the switchbox, and the power cable from the distribution box of PU-699/M is connected to Load 1 of the switchbox. The power cable from the DE of the PU-700/M is connected to Gen 2 of the switchbox, and power cable from distribution box of PU-700/M is connected to Load 2 of the switchbox. Paralleling of the two 60KW generator sets is automatically controlled. Control of power is by four circuit breaker switches.

*b. Circuit Breaker Switches.* The four circuit breaker switches on the switchbox should operate

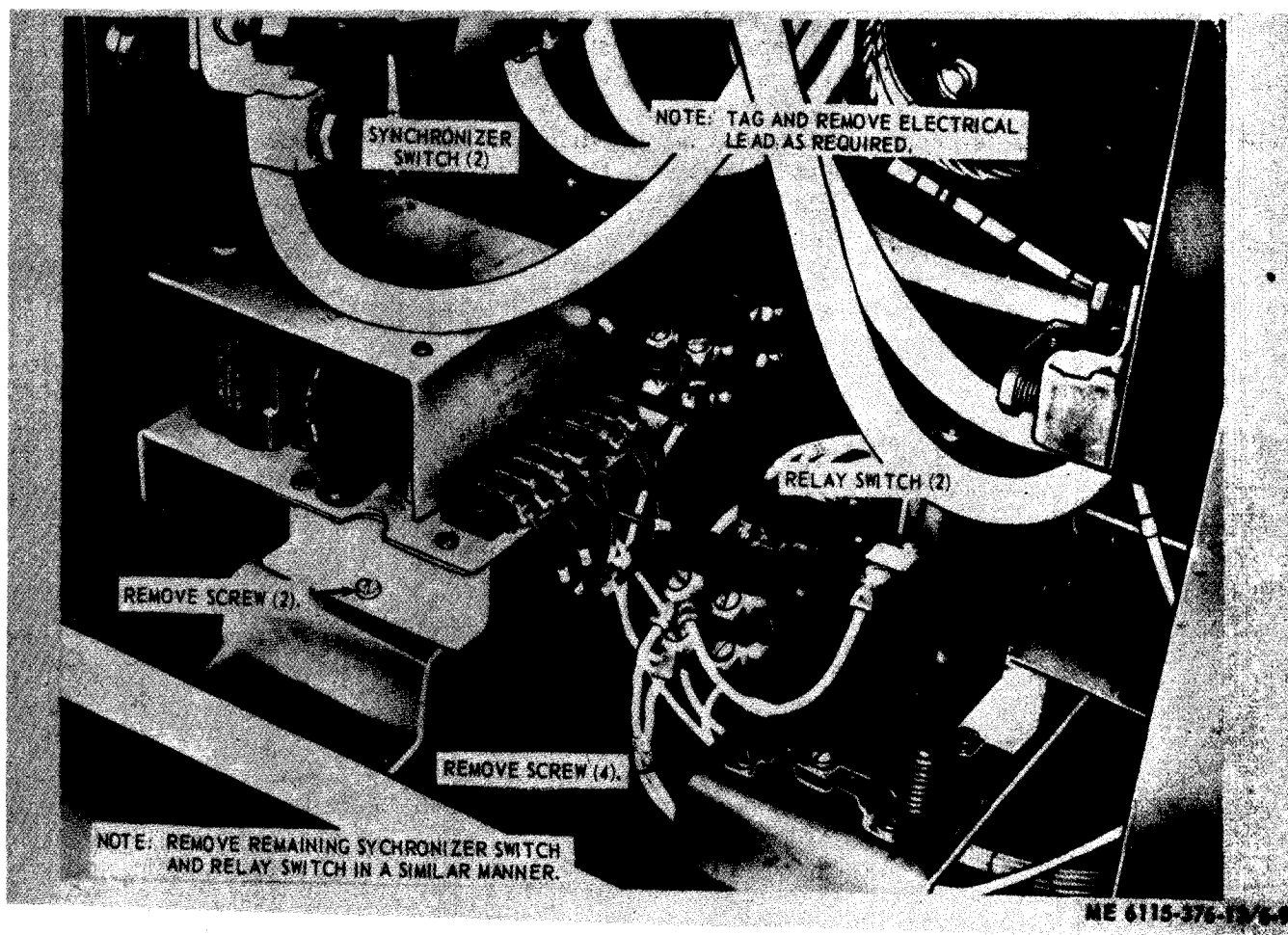

Figure 6-9. Relay switch assembly and electronic synchronizer switch assembly, removal and installation.

with an audible snap, If the switch works too easy or does not make good contact, the circuit breaker switch is defective and must be replaced. To replace a circuit breaker switch proceed as follows :

(1) Open cover and remove top and bottom front panels, and lock panel (fig. 6-10 (1)).

(2) Refer to figure 6-10(2) and tag and disconnect power leads at top and bottom of defective circuit breaker,

(3) Remove attaching hardware (fig. 6-10 (2) ) and pull circuit breaker from front of panel.

(4) Place replacement circuit breaker switch in position on cross bar of switchbox, and secure with attaching hardware. Install the six power leads, and panels. Close cover.

## 6-7. Wiring

*a. General.* The electrical circuits in the distribution box, portable distribution box, synchronizer assembly or switchbox, are completed by either individual wire leads or several leads inclosed in a wiring harness. All wiring carries code numbers and/or a color coding. When testing, repairing, or replacing leads or a harness, refer to the applicable wiring diagram. The wiring diagram for the synchronizer assembly is on top of the assembly; on inside back panel of the distribution box and switchbox; and on bottom inside of the portable distribution box.

*b. Inspection.* Inspect wiring for cracked or frayed insulation. Broken or cut wires must be replaced. If the break is in an accessible place, replace the wire, Cracked or frayed insulation, if the wire is exposed, must be repaired.

*c. Testing.* Disconnect each end of the lead and with a multimeter, test for continuity. If continuity is not indicated, the lead has a break and must be repaired or replaced.

*d. Repair.* Remove insulation on the lead to expose one half inch of bare wire on both sides of the break. Clean both exposed wires, twist them together, and solder the connections. Cover soldered connection with electrical tape and function tape. Do not leave any bare wire exposed. Repair cracked or frayed insulation, if the wire is exposed, by covering with electrical tape and function tape. If a terminal lug breaks off a wire, replace it, using an exact duplicate terminal lug.

*e. Replacement.* Replace a lead by disconnecting both ends from the component (s). If the lead is not part of a harness, remove the lead and install a new one. If the lead to be replaced is part of a harness, tape both disconnected ends, install a new lead and attach new lead to outside of the wiring harness, Replacement leads should be of the same color wire and tagged with code numbers, and must be of same wire size and characteristics as the original.

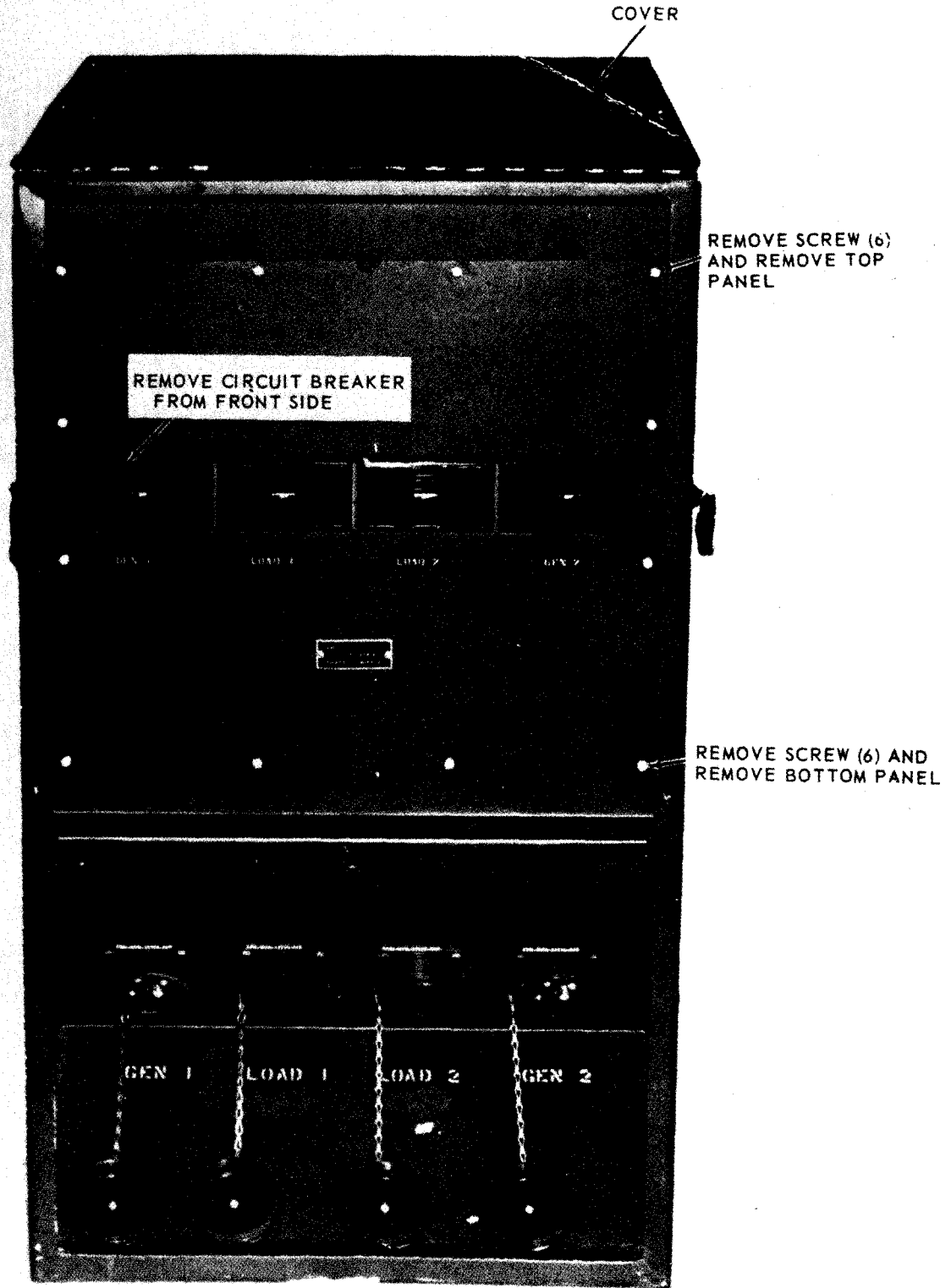

ME 6115-376-13/6-10 ①

Figure 6-10. Switchbox circuit breaker switches, removal and installation (sheet 1 of 2).

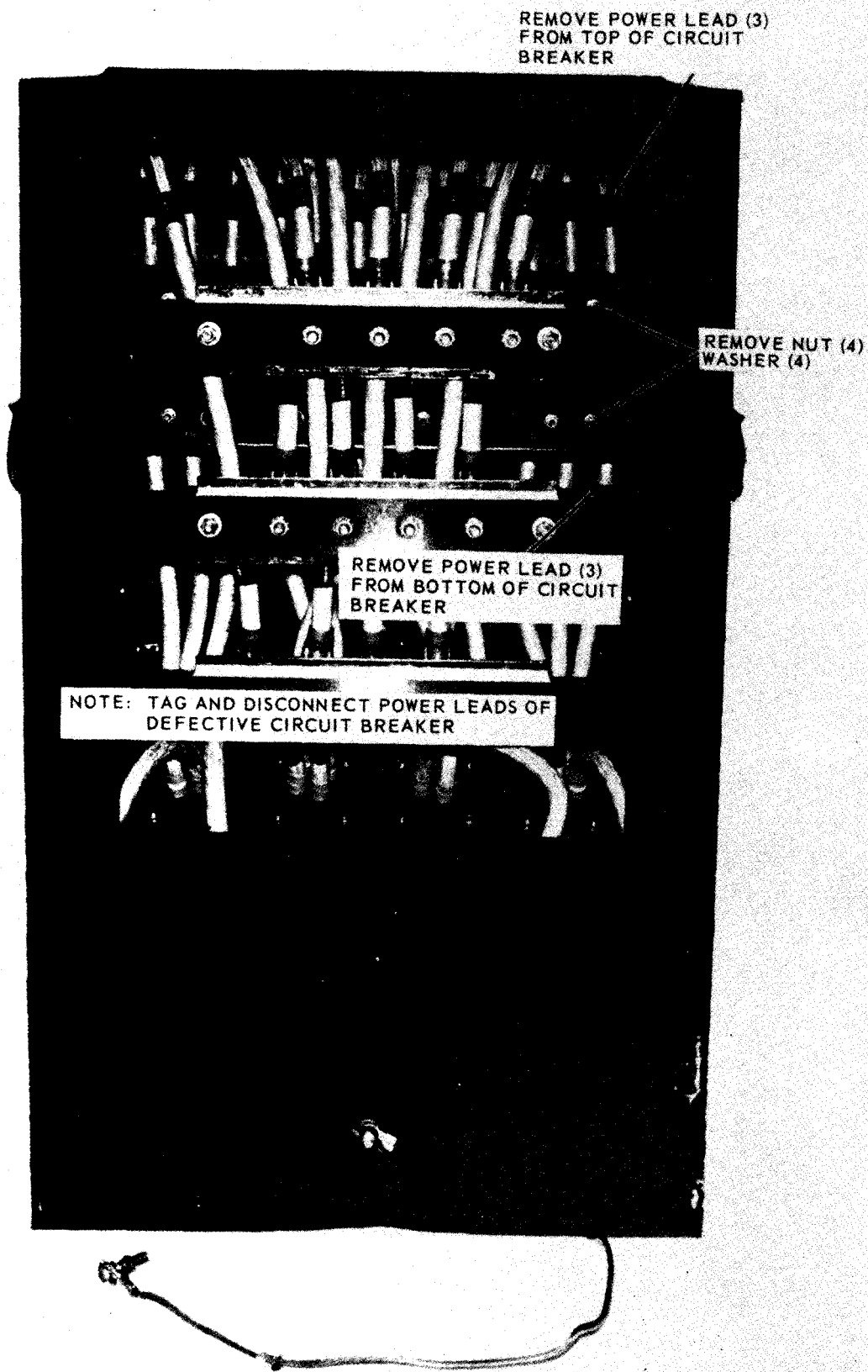

ME 6115-376-13/6-10②

Figure 6-10. Switchbox circuit breaker switches removal and installation (sheet 2 of 2).





## APPENDIX A

### REFERENCES

#### A-1. Fire Protection

TB 5-4200-200-10 Hand Portable Fire Extinguishers Approved for Army Troop Users.

#### A-2. Lubrication

C9100-IL Fuels, Lubricants, Oils and Waxes.  
 LO 5-6115-239-20 Generator Set. Diesel Engine: 45KW, AC, 120/208, 240/416V, 3 Phase, 60 Cycle, Convertible to 37.5 KW, 50 Cycle; Skid Mounted (Consolidated Diesel Electric Model 4070) w/Continental Engine Model TD 427.  
 LO 5-6115-247-15 Generator Set, Diesel Engine: 45KW, AC, 120/208, 240/416V, 3 Phase, 50/60 Cycle; Skid Mounted; Winterized (Stewart & Stevenson Model 54400) FSN 6115-970-0006.  
 LO 5-6115-425-12 Generator Set, Diesel Engine: 60KW 120/208-240/416V, 3 Phase, 4 Wire, 50-60 Hertz, Liquid Cooled, Skid Mounted (Military Design SF-60-MD/CIED), w/Cummins Engine Model C180 and Generator Set, Diesel Engine: 60KW 120/208-240/416V, 3 Phase, 400 Hertz Liquid Cooled, Skid Mounted (Military Design HF-60-MD/CIED) w/Cummins Engine Model C180.  
 LO 9-2320-211-12 Truck Chassis: 5-Ton, 6 x 6, M39, M40, M40C, M61, M61A2, M63, M63C, M139, M139C, M139D, M139F; truck Cargo: 5-Ton, 6x6 M41, M54, M54A1, M54A2, M55, M55A2; truck Dump: 5-Ton; 6x6, M51, M51A2, Truck Tractor, 5-Ton, 6x6, M52, M52A1, M52A2: Truck Tractor, Wrecker: 5-Ton, 6x6, M246; Truck, Wrecker: Medium, 5-Ton 6x6, M62, M543, M543A2.

#### A-3. Painting

TM 9-213 Painting Instructions for Field Use.

#### A-4. Radio Suppression

TM 11-483 Radio Interference Suppression.

#### A-5. Maintenance

TM 5-6115-239-10 Operators Manual, DE Generator Set 45KW, Model 4070.  
 TM 5-6115-247-15 Operators Organizational, DS, GS and Depot Manual, 45KW DE Generator Set, Model 54400.  
 TM 66115-425-12 Operator and Organizational Maintenance Manual, 60KW DE Generator Set, Military Design SF 60MD/CIED.  
 TM 9-2320-211-12 Operator and Organizational Maintenance Manual, M54A2 Cargo Truck 6 x 6, 5-Ton.  
 TM 9-2320-205-14 Operator, Organizational DS and GS Maintenance Manual, Generator Trailer M200A1.  
 TM 5-764 Electric Motor and Generator Repair.  
 TM 9-207 Operation and Maintenance of Army Materiel in Extreme Cold Weather (-0° to -65°F.)  
 TM 9-6140-200-15 Operation and Organizational DS and GS and Depot Maintenance: Storage Batteries, Lead Acid Type.  
 TM 38-750 Army Equipment Record Procedures.  
 TM 11-5527 Multimeters.  
 TM 11-6625-203-12 Operator and Organizational Maintenance Manual AN/URM-I-5 Multimeter,

**A-6. Shipment, Storage and Destruction**

- |              |   |
|--------------|---|
| TM 740-93-2  | Preservation of USAMEC Mechanical Equipment for Shipment and Storage. |
| TM 740-93-3  | Administrative Storage of USAMEC Mechanical Equipment.                |
| TM 750-244-3 | Procedures for Destruction of Equipment to Prevent Enemy Use.         |

## APPENDIX B

## MAINTENANCE ALLOCATION CHART

## Section 1. INTRODUCTION

**B-1. General**

*a.* This section provides a general explanation of all maintenance and repair functions authorized at various maintenance levels.

*b.* Section II designates overall responsibility for the performance of maintenance functions on the identified end item or component. The implementation of the maintenance functions upon the end item or component will be consistent with the assigned maintenance functions.

*c.* Section 111 (Special Tools and Test Equipment ) -Not applicable.

*d.* Section IV contains supplemental instructions, explanatory notes and/or illustrations required for a particular maintenance function.

**B-2. Explanation of Columns in Section II**

*a. Group Number, Column (1).* The assembly group is a numerical group assigned to each assembly in a top down breakdown sequence. The applicable assembly groups are listed on the MAC in disassembly sequence beginning with the first assembly removed in a top down disassembly sequence.

*b. Assembly Group, Column (2).* This column contains a brief description of the components of each assembly group.

*c. Maintenance Functions, Column (3).* This column lists the various maintenance functions (A through K) and indicates the lowest maintenance category authorized to perform these functions. The symbol designations for the various maintenance categories are as follows:

- G--Operator or Crew**
- O--Organizational Maintenance**
- F--Direct Support Maintenance**
- H--General Support Maintenance**
- D--Depot Maintenance**

The maintenance functions are defined as follows:

**A-Inspect.** To determine serviceability of an item by comparing its physical, mechanical, and electrical characteristics with established standards.

**B-Test.** To verify serviceability and to detect electrical or mechanical failure by use of test equipment.

**C-Service.** To clean, to preserve, to charge, and to add fuel, lubricants, cooling agents, and air. If it is desired that elements, such as painting and lubricating, be defined separately, they may be so listed.

**D-Adjust.** To rectify to the extent necessary to bring into proper operating range.

**E-Align.** To adjust specified variable elements of an item to bring to optimum performance.

**F-Calibrate.** To determine the corrections to be made in the readings of instruments or test equipment used in precise measurement. Consists of the comparison of two instruments, one of which is a certified standard of known accuracy, to detect and adjust any discrepancy in the accuracy of the instrument being compared with the certified standard.

**G-Install.** To set up for use in an operational environment such as an emplacement, site, or vehicle.

**H-Replace.** To replace unserviceable items with serviceable like items.

**I-Repair.** Those maintenance operations necessary to restore an item to serviceable condition through correction of material damage or a specific failure. Repair may be accomplished at each category of maintenance.

**J-Overhaul,** Normally, the highest degree of maintenance performed by the Army in order to minimize time work in process is consistent with quality and economy of operation. It consists of that maintenance necessary to restore an item to completely serviceable condition as prescribed by maintenance standards in technical publications for each item of equipment. Overhaul normally does not return an item to like new, zero mileage or zero hour condition.

**K-Rebuild.** The highest degree of materiel maintenance. It consists of restoring equipment as nearly as possible to new condition in accordance with original manufacturing standards. Rebuild is performed only when required by op-

erational considerations or other paramount factors and then only at the depot maintenance category. Rebuild reduces to zero the hours or miles the equipment, or component thereof, has been in use.

**d. Tools and Equipment, Column (4).** This column is provided for referencing by code the special tools and test equipment, (sec. III) required to perform the maintenance functions (sec. II).

**c. Remarks, Column (5).** This column is provided for referencing by code the remarks (sec.

IV) pertinent to the maintenance functions,

**B-3. Explanation of Columns in Section IV**

**a. Reference Code.** This column consists of two letters separated by a dash, both of which are references to section H, The first letter references column 5 and the second letter references a maintenance function, column 3, A through K.

**b. Remarks.** This column lists information pertinent to the maintenance function being performed, as indicated on the MAC, section II.

**Section II. MAINTENANCE ALLOCATION CHART**

(1) Group No.	(2) Functional Group	(3) Maintenance Functions											(4) Tools and Equipment	(5) Remarks	
		A Inspect	B Test	C Service	D Adjust	E Align	F Calibrate	G Install	H Replace	I Repair	J Overhaul	K Rebuild			
01	Generator Assembly														A,D
02	Trailer (M200A1),														B,D
08	Cables Power -----	C	O						O						
04	Skid Platform -----	C							F						
04	Truck (M54A2)														
06	Cables, Power -----	C	O						O						C,D
06	Brackets, Braces, Mounting														
06	Bases, Frames, and														
06	Accessory Boxes -----	C							O						
06	Distribution Boxes (All Units)	O							F						
	Circuit breakers -----	O							F						
	Distribution panel assy -----	O							F						
	Connector, receptacles -----	C							O						
	Covers, receptacles -----	C							O						
	Ammeters -----	O							F						
	Transformers, current -----	O							F						
	Wiring -----	O	F						F						
	Indicator lights and lens -----	O							O						
	Lamp socket assemblies -----	O							F						
	Portable distribution box duplex														
	receptacles, circuit breaker														
	switches lamp socket														
	assemblies -----	O							F						
07	Synchronizer Assy -----	O	O						F						
	Circuit breakers -----	O							F						
	Electronic synchronizer -----	F							F						
	Toggle switches -----	O							O						
	Connector receptacles -----	C							O						
	Covers, receptacles -----	C							O						
	Wiring -----	O	F						F						
	Indicator lights and lens -----	O							O						
	Lamp socket assemblies -----	O							F						
	Relay switches -----	F							F						
	Automatic switch -----	F			F				F						
08	Switch Box -----	O	O						F						
	Circuit breakers -----	O							F						
	Connector receptacles -----	C							O						
	Covers, receptacles -----	C							O						
	Wiring -----	O	F						F						

**Section IV. REMARKS**

Reference Code	Remarks
A-H	For maintenance of generator sets refer to TM 3-6115-239-10 and TM 5-6115-247-15 (45KW), or TM 5-6115-425-12 (60KW).
B-H	For maintenance of M200A1 trailer, refer to TM 9-2330-206-14.
C-H	For maintenance of M54A2 truck, refer to TM 9-2320-211-10.
D-H	For maintenance of diesel engines, refer to TM 5-6115-239-10 or TM S-6115-247-15 (45KW), and TM 6-6116-426-12 (60KW).



**APPENDIX C**  
**BASIC ISSUE ITEMS LIST**

Section 1. INTRODUCTION

**C-1. Scope**

This appendix lists items which accompany the generator sets or are required for installation, operation, or operator's maintenance.

**C-2. General**

This Basic Issue Items List is divided into the following sections:

*a. Basic Issue Items—Section II.* A list of items which accompany the generator sets are required by the operator/crew for installation, operation, or maintenance.

*b. Maintenance and Operating Supplies--Section III.* Not applicable.

**C-3. Explanation of Columns**

The following provides an explanation of columns in the tabular list of Basic Issue Items, section II.

*a. Source, Maintenance, and Recoverability Codes (SMR).*

(1) Source code indicates the source for the listed item. Source codes are:

<i>Code</i>	<i>Explanation</i>
<b>P</b>	Repair parts which are stocked in or supplied from the GSA/DSA, or Army supply system and authorized for use at indicated maintenance categories.
<b>P2</b>	Repair parts which are procured and stocked for insurance purposes because the combat or military essentiality of the end item dictates that a minimum quantity be available in the supply system.
<b>M</b>	Repair parts which are not procured or stocked, but are to be manufactured in indicated maintenance levels.
<b>A</b>	Assemblies which are not procured or stocked as such, but are made up of two or more units. Such component units carry individual stock numbers and descriptions, are procured and stocked separately and can be assembled to form the required assembly at indicated maintenance categories.
<b>X</b>	Parts and assemblies which are not procured or stocked and the mortality of which normally is below that of the applicable end item or component. The failure of such part or assembly should result in retirement of the end item from the supply system.

<i>Code</i>	<i>Explanation</i>
<b>X1</b>	Repair parts which are not procured or stocked. The requirement for such items will be filled by use of the next higher assembly or component.
<b>X2</b>	Repair parts which are not stocked. The indicated maintenance category requiring such repair parts will attempt to obtain them through cannibalization, requirements will be requisitioned with accompanying justification, through normal supply channels.
<b>G</b>	Major assemblies that are procured with PEMA funds for initial issue only as exchange assemblies at DSU and GSU level. These assemblies will not be stocked above GS and DS level or returned to depot supply level.

(2) Maintenance code indicates the lowest category of maintenance authorized to install the listed item. The maintenance level code is:

<i>Code</i>	<i>Explanation</i>
<b>C</b>	Operator/Crew

(3) Recoverability code, indicates whether unserviceable items should be returned for recovery or salvage. Items not coded are expendable. Recoverability codes are:

<i>Code</i>	<i>Explanation</i>
<b>R</b>	Repair parts (assemblies and components) which are considered economically repairable at direct and general support maintenance levels. When the maintenance capability to repair these items does not exist, they are normally disposed of! at the GS level. When supply considerations dictate, some of these repair parts may be listed for automatic return to supply for depot level repair as set forth in AR 710-50. When so listed, they will be replaced by supply on an exchange basis.
<b>S</b>	Repair parts and assemblies which are economically repairable at DSU and GSU activities and which normally are furnished by supply on an exchange basis. When items are determined by a GSU to be uneconomically repairable they will be evacuated to a depot for evaluation and analysis before final disposition.
<b>T</b>	High dollar value recoverable repair parts which are subject to special handling and are issued on an exchange basis. Such repair parts normally are repaired or overhauled at depot maintenance activities,

Code	Explanation
U	Repair parts specifically selected for salvage by reclamation units because of precious metal content, critical materials, or high dollar value reusable casings or castings.

**b. Federal Stock Number.** This column indicates the Federal stock number assigned to the item and will be used for requisitioning purposes.

**c. Description.** This column indicates the Federal item name and any additional description of the item required. The abbreviation "w/e", when used as a part of the nomenclature, indicates the Federal stock number includes all armament, equipment, accessories, and repair parts issued with the item. A part number or other reference number is followed by the applicable five-digit Federal supply code for manufacturers in parenthesis. Repair parts quantities included in kits, sets, and assemblies are shown in front of the repair part name.

**d. Unit of Measure (U/M).** A two character alphabetic abbreviation indicating the amount or quantity of the item upon which the allowances are based, e.g., ft, ea, pr, etc.

**e. Quantity Incorporated In Unit.** This column indicates the quantity of the item used in the assembly group. A "V" appearing in this column in lieu of a quantity indicates that a definite quantity cannot be indicated (e.g. shims, spacers, etc.)

**f. Quantity Furnished With Equipment.** This column indicates the quantity of an item furnished with the equipment.

**g. Illustration.** This column is divided as follows :

(1) **Figure number.** Indicates the figure number of the illustration in which the item is shown.

(2) **Item number.** Indicates the callout number used to reference the item in the illustration.

### Section II. Basic Issue Items

(1) SMR Code	(2) Federal Stock Number	(3) Description  RefNo. & Mfr. Code	(4) Unit of Meas.	(5) Qty. Inc. in Unit	(6) Qty. Furn. With Equip.	(7) Illustration	
						(A) Fig. No.	(B) Item No.
PC	2910-066-1235	Adapter Assembly: Fuel Drain 1321 <b>1E7541</b> (97403) Army Technical Manuals TM 5-6115-239-10 TM 5-6115-247-15 <b>TM</b> 5-6115-425-12 TM 9-2320-211-12 <b>TM</b> 9-2330-205-14 Army Lubrication Orders LO 5-6115-239-12 LO 5-6115-247-12 LO 5-6115-425-12 LO 9-2320-211-12 LO 9-2330-205-12	ea		1		
PC	7520-659-9618	Case: Operator and Maintenance Publications			1		
PC	4210-270-4572	Extinguisher, Fire: <b>Hand, 5 Lb, O-E-910</b> Type I, Size 5			1		
PC	<b>5120-203-4656</b>	Hammer, Sledge: 8 <b>Ib. GGG-H-86</b> Type I, Class I			1		
PC	5975-878-3991	Rod, Ground: MI <b>L-R-11461</b> , Type 2, Style 2			2		



INDEX

	Paragraph	Page
<b>A</b>		
Ancillary items-----	4-17	4-8
<b>B</b>		
Basicissueitems-----	3-2	3-1
Batteries, generator set -----	4-10	4-5
Brackets, fuel can -----	4-11	4-5
<b>C</b>		
Cables, power-----	4-12, 4-13	4-5,4-6
Checks and services, preventive maintenance -----	3-6,4-6	3-1,4-1
Cold weather starting aids, winterization kits, and heaters -----	2-20	2-16
Component troubleshooting -----	4-8	4-4
Connections, ground -----	2-4	2-2
Connections, power distribution -----	2-6,2-7	2-3,2-4
Controls and instruments -----	2-11	2-6
<b>D</b>		
Data, tabulated -----	1-5	1-1
DE generator set -----	5-9	5-2
Description -----	1-3	1-1
Description of major components -----	1-6	1-9
Description of minor components -----	1-7	1-16
Detailed lubrication information -----	3-4	3-1
Differences between models -----	1-4	1-1
Dismantling for movement -----	2-8	2-6
Distribution box -----	4-18,5-6,6-3	4-8,5-2,6-1
Distribution box, portable -----	6-4	6-3
<b>E</b>		
Equipment, operation of -----	2-16	2-15
External fuel line connection -----	2-3	2-1
<b>F.</b>		
Fire extinguisher -----	2-19	2-16
Forms and records -----	1-2	1-1
Fuel can brackets -----	4-11	4-5
Fuel line connection, external -----	2-3	2-1
<b>G</b>		
General -----	2-10,2-16,3-3, 3-5,3-8,4-5, 4-7,4-9	2-6,2-15,3-1, 3-1,3-3,4-1, 4-4,4-5
General maintenance -----	5-5	5-2
Generator set -----	6-1	6-1
Generator set batteries -----	4-10	4-5
Generator setDE -----	5-9	5-2
Ground connections -----	2-4	2-2
<b>I</b>		
Inspecting and servicing equipment -----	2-1,4-1	2-1, 4-1
Inspection, pre-operational -----	2-13	2-14
Installation -----	2-2	2-1
Instruments and Controls -----	2-11	2-6
Inter-unit connections primary-standby -----	2-5	2-3
<b>L</b>		
Lubrication information, detailed -----	3-4	3-1
<b>M</b>		
Maintenance, general -----	5-5	5-2
Maintenance, operators -----	3-9	3-3
Maintenance repair parts -----	4-4,5-3	4-1,5-1
Major components description -----	1-6	1-9
Minor component description -----	1-7	1-16
Models, differences between -----	1-4	1-1
Movement, dismantling for -----	2-8	2-6

	Paragraph	Page
<b>O</b>		
Operation of equipment -----	2-16	2-15
Operator's maintenance _____	3-9	3-3
<b>P</b>		
Platform, skid -----	5-10	5-3
Portable distribution box _____	6-4	6-3
Power cable (45KW) -----	4-12	4-5
Power cable (60KW) _____	4-13	4-6
Power cable, testing _____	4-14	4-6
Power distribution connections (45KW) _____	2-6	2-3
Power distribution connections (60KW) _____	2-7	2-4
Preventive maintenance checks and services -----	3-6,4-6	3-1,4-1
Pre-operational inspection _____	2-13	2-14
Primary standby inter-unit connections _____	2-5	2-3
PU-407/MandPU-408/M -----	2-17	2-16
PU-699/M and PU-700/M -----	2-18	2-16
<b>R</b>		
Records and forms -----	1-2	1-1
Reinstallation after movement -----	2-9	2-6
Repair parts, maintenance -----	4-4,5-3	4-1,5-1
<b>S</b>		
scope -----	1-1	1-1
Servicing equipment -----	2-1	2-1
Skid platform -----	5-10	5-3
Special tools and equipment -----	3-1,4-3,5-2	3-1,4-1, 5-1
Starting -----	2-14	2-14
Stopping -----	2-15	2-15
Switchbox -----	4-20,5-8, 6-6	4-12,5-2,6-10
Switchbox, testing -----	4-16	4-8
Synchronizer assembly -----	4-19,5-7,6-5	4-12,5-2, 6-7
Synchronizer assembly, testing -----	4-15	4-8
<b>T</b>		
Tabulated data _____	1-5	1-1
Testing power cables (45KW) _____	4-14	4-6
Testing switchbox _____	4-16	4-8
Testing synchronizer assembly _____	4-15	4-8
Tools and equipment _____	4-2,5-1	4-1,5-1
Trailer and Truck _____	6-2	6-1
Troubleshooting _____	3-7,5-4	3-3,5-1
Troubleshooting component _____	4-8	4-4
<b>w</b>		
Winterization kits, heaters and cold weather starting aids _____	2-20	2-16
Wiring _____	6-7	6-11



